

# PRX818XLFW 18" Self-Powered Extended Low Frequency Subwoofer System

## Features:

- ▶ Maximum SPL Output 134 dB Peak
- ▶ 18" Differential Drive® low-frequency driver for low-distortion and higher SPL
- ▶ 1500W highly efficient Class-D amplifier
- ▶ Wireless remote control of its onboard DSP EQ parameters via Wi-Fi. Control and configure your show from anywhere.
- ▶ DSP input limiter circuit, crossover, dynamic limiting, and component optimization
- ▶ Professional XLR-1/4" combination inputs and XLR loop-through
- ▶ Top panel M20 pole mount socket for sub/satellite configuration
- ▶ Injection molded handles with comfort rubber grips for easy transport
- ▶ Lightweight poplar plywood cabinets made structurally sound with tongue and groove joints and protected by JBL's tour proven DuraFlex™ finish

## Application:

- ▶ The PRX818XLFW extended low frequency subwoofer was designed and engineered to provide sub bass frequencies with accuracy and power. Used as a single sub in a sub/sat system or in multiples as part of a scalable, large format sound reinforcement system, the PRX818XLFW performs with exceptional efficiency and control. The subs are stackable and light-weight ensuring quick set-ups and tear-downs. And due to their rugged construction are perfect for AV rental inventories. With a pole receptacle (that accepts a SS4-BK or SS4-BK24) on the top panel and integrated stereo pass-thru this is the most powerful low-frequency complement to the PRX full-range systems. The addition of a polarity reverse option further enables system optimization.
- ▶ The PRX818XLFW is a high performance self-powered subwoofer system with remote Wi-Fi control of onboard DSP EQ parameters. The PRX818XLFW is comprised of a powerful 2278G Differential Drive® dual voice-coil and magnetic gap, woofer driven by a 1500 Watt Class-D power amplifier. Sophisticated DSP is at the core of a fully featured input section, providing user selectable cross-over functionality, polarity optimization, protection, dynamic limiting and discrete component optimization.
- ▶ All PRX800 cabinets are built from a combination of 25 mm (on the top and bottom for added rigidity) and 18 mm, strong, light-weight poplar plywood made structurally sound with tongue and groove joints. All PRX800 Series cabinets are protected by JBL's tour proven DuraFlex™ finish. Grilles are made from dent-resistant 16 gauge steel and handles are made from light-weight glass-filled nylon for added strength and durability.
- ▶ The amplifier input panel offers stereo inputs with XLR or 1/4 inch jack compatibility. A user selectable crossover ensures a smooth transition to full-range system connected to the stereo outputs. Signal present and limiter lights indicate the system status and assist in setting the optimum level via the level control knob.



## Specifications:

### System:

System Type:	Self Powered 18" subwoofer
Maximum SPL Output:	134 dB peak
Frequency Range (-10 dB):	30 Hz - 103 Hz
Frequency Response (±3 dB):	35 Hz - 87 Hz
Input Connectors:	Two Balanced female XLR/ 1/4" combo connectors
Input Impedance:	20K Ohms (balanced)
Signal Indicators:	Limit: Yellow LED indicates peak output has been reached and dsp limiter is acting Signal: Green LED indicates signal present Power: Blue indicates system has power and ready to pass audio.
Dynamic Control (Input):	dbx Type IV™ limiter circuit
Internal Crossover Frequency:	100 Hz DSP
Loop out Crossover Frequency:	120 Hz analog 24 dB filter slope

### Amplifier:

Design:	Highly efficient Class-D amplifier
Power Rating:	1500W
AC Power Input:	100V - 240V ~ 50/60 Hz

### Speaker:

LF Driver:	1 x JBL 2278G 460 mm (18 in) woofer
Enclosure:	Rectangular, 18 mm, plywood
Transport:	2 x injection molded handles with backing cup
Finish:	Obsidian DuraFlex™ finish
Grille:	Powder coated, Obsidian, 16 gauge perforated steel with acoustical transparent black cloth backing.
Dimensions (H x W x D):	692 mm x 523 mm x 724 mm (27.26 in x 20.6 in x 28.5 in)
Net Weight:	36.8 kg (81 lb)
Gross Weight:	45.0 kg (100.0 lb)

JBL continually engages in research related to product improvement. Some materials, production methods and design refinements are introduced into existing products without notice as a routine expression of that philosophy. For this reason, any current JBL product may differ in some respect from its published description, but will always equal or exceed the original design specifications unless otherwise stated.

# ► PRX818XLFW 18" Self-Powered Extended Low Frequency Subwoofer System

## Frequency Response:

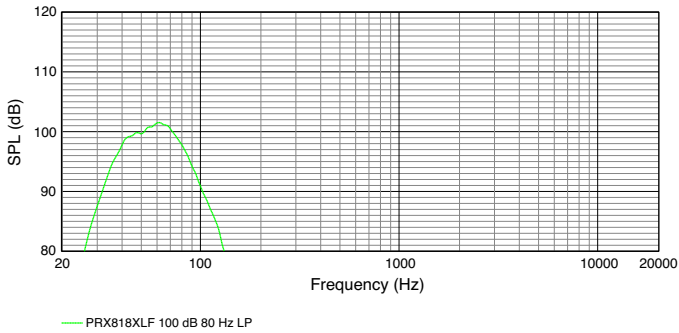

## Block Diagram:

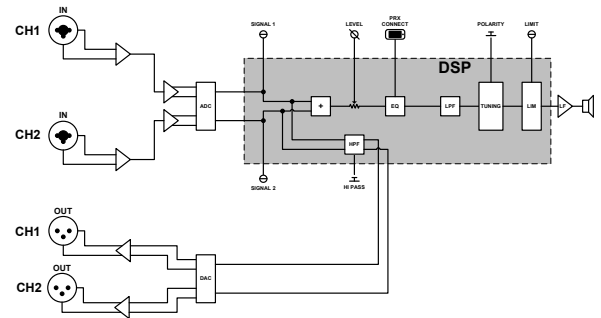

## Dimensions:

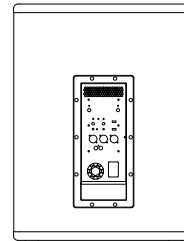
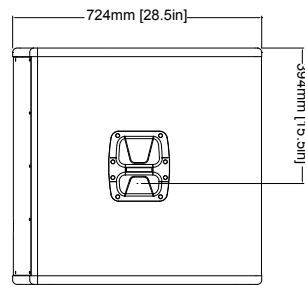
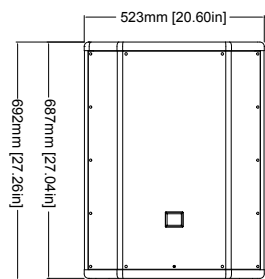
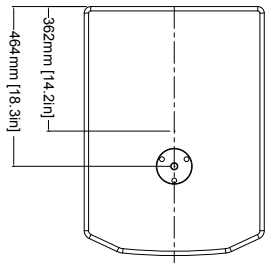

mm [in]

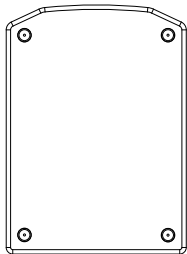

Dimensions in mm (in)



JBL Professional  
8500 Balboa Boulevard, P.O. Box 2200  
Northridge, California 91329 U.S.A.

© Copyright 2016 JBL Professional  
[www.jblpro.com](http://www.jblpro.com)

PN: 5075807  
SS PRX818XLFW  
CRP  
06/16