



INSTRUCTION MANUAL

N2400 SERIES N2412A ENCODERS/N2422A DECODERS
DIGITAL MEDIA DISTRIBUTION & SWITCHING SOLUTION

NMX-ENC-N2412A, NMX-DEC-N2422A



IMPORTANT SAFETY INSTRUCTIONS

1. READ these instructions.
2. KEEP these instructions.
3. HEED all warnings.
4. FOLLOW all instructions.
5. DO NOT use this apparatus near water.
6. CLEAN ONLY with dry cloth.
7. DO NOT block any ventilation openings. Install in accordance with the manufacturer's instructions.
8. DO NOT install near any heat sources such as radiators, heat registers, stoves, or other apparatus (including amplifiers) that produce heat.
9. DO NOT defeat the safety purpose of the polarized or grounding type plug. A polarized plug has two blades with one wider than the other. A grounding type plug has two blades and a third grounding prong. The wider blade or the third prong are provided for your safety. If the provided plug does not fit into your outlet, consult an electrician for replacement of the obsolete outlet.
10. PROTECT the power cord from being walked on or pinched, particularly at plugs, convenience receptacles, and the point where they exit from the apparatus.
11. ONLY USE attachments/accessories specified by the manufacturer.



12. USE ONLY with a cart, stand, tripod, bracket, or table specified by the manufacturer, or sold with the apparatus. When a cart is used, use caution when moving the cart/apparatus combination to avoid injury from tip-over.
13. UNPLUG this apparatus during lightning storms or when unused for long periods of time.
14. REFER all servicing to qualified service personnel. Servicing is required when the apparatus has been damaged in any way, such as power-supply cord or plug is damaged, liquid has been spilled or objects have fallen into the apparatus, the apparatus has been exposed to rain or moisture, does not operate normally, or has been dropped.
15. DO NOT expose this apparatus to dripping or splashing and ensure that no objects filled with liquids, such as vases, are placed on the apparatus.
16. To completely disconnect this apparatus from the AC Mains, disconnect the power supply cord plug from the AC receptacle.
17. Where the mains plug or an appliance coupler is used as the disconnect device, the disconnect device shall remain readily operable.
18. DO NOT overload wall outlets or extension cords beyond their rated capacity as this can cause electric shock or fire.



The exclamation point, within an equilateral triangle, is intended to alert the user to the presence of important operating and maintenance (servicing) instructions in the literature accompanying the product.



The lightning flash with arrowhead symbol within an equilateral triangle is intended to alert the user to the presence of uninsulated "dangerous voltage" within the product's enclosure that may be of sufficient magnitude to constitute a risk of electrical shock to persons.



ESD Warning: The icon to the left indicates text regarding potential danger associated with the discharge of static electricity from an outside source (such as human hands) into an integrated circuit, often resulting in damage to the circuit.

- WARNING:** To reduce the risk of fire or electrical shock, do not expose this apparatus to rain or moisture.
- WARNING:** No naked flame sources - such as candles - should be placed on the product.
- WARNING:** Equipment shall be connected to a MAINS socket outlet with a protective earthing connection.
- WARNING:** To reduce the risk of electric shock, grounding of the center pin of this plug must be maintained.

COPYRIGHT NOTICE

AMX© 2018, all rights reserved. No part of this publication may be reproduced, stored in a retrieval system, or transmitted, in any form or by any means, electronic, mechanical, photocopying, recording, or otherwise, without the prior written permission of AMX. Copyright protection claimed extends to AMX hardware and software and includes all forms and matters copyrightable material and information now allowed by statutory or judicial law or herein after granted, including without limitation, material generated from the software programs which are displayed on the screen such as icons, screen display looks, etc. Reproduction or disassembly of embodied computer programs or algorithms is expressly prohibited.

LIABILITY NOTICE

No patent liability is assumed with respect to the use of information contained herein. While every precaution has been taken in the preparation of this publication, AMX assumes no responsibility for error or omissions. No liability is assumed for damages resulting from the use of the information contained herein. Further, this publication and features described herein are subject to change without notice.

AMX WARRANTY AND RETURN POLICY

The AMX Warranty and Return Policy and related documents can be viewed/downloaded at www.amx.com.

ESD WARNING

	<p>To avoid ESD (Electrostatic Discharge) damage to sensitive components, make sure you are properly grounded before touching any internal materials.</p> <p>When working with any equipment manufactured with electronic devices, proper ESD grounding procedures must be followed to make sure people, products, and tools are as free of static charges as possible. Grounding straps, conductive smocks, and conductive work mats are specifically designed for this purpose.</p> <p>Anyone performing field maintenance on AMX equipment should use an appropriate ESD field service kit complete with at least a dissipative work mat with a ground cord and a UL listed adjustable wrist strap with another ground cord</p>
---	--

	<p>WARNING: Do Not Open! Risk of Electrical Shock. Voltages in this equipment are hazardous to life. No user-serviceable parts inside. Refer all servicing to qualified service personnel. Place the equipment near a main power supply outlet and make sure that you can easily access the power breaker switch.</p>
---	--

WARNING: This product is intended to be operated ONLY from the voltages listed on the back panel or the recommended, or included, power supply of the product. Operation from other voltages other than those indicated may cause irreversible damage to the product and void the products warranty. The use of AC Plug Adapters is cautioned because it can allow the product to be plugged into voltages in which the product was not designed to operate. If the product is equipped with a detachable power cord, use only the type provided with your product or by your local distributor and/or retailer. If you are unsure of the correct operational voltage, please contact your local distributor and/or retailer.

FCC AND CANADA EMC COMPLIANCE INFORMATION:

This device complies with part 15 of the FCC Rules. Operation is subject to the following two conditions:

- (1) This device may not cause harmful interference, and
- (2) this device must accept any interference received, including interference that may cause undesired operation.

NOTE: This equipment has been tested and found to comply with the limits for a Class A digital device, pursuant to part 15 of the FCC Rules. These limits are designed to provide reasonable protection against harmful interference in a commercial environment. This equipment generates, uses and can radiate radio frequency energy and, if not installed and used in accordance with the instructions, may cause harmful interference to radio communications. However, there is no guarantee that interference will not occur in a particular installation. If this equipment does cause harmful interference to radio or television reception, which can be determined by turning the equipment off and on, the user is encouraged to try to correct the interference by one or more of the following measures:

- Reorient or relocate the receiving antenna.
- Increase the separation between the equipment and receiver.
- Connect the equipment into an outlet on a circuit different from that to which the receiver is connected.
- Consult the dealer or an experienced radio/TV technician for help.

Approved under the verification provision of FCC Part 15 as a Class A Digital Device.

Caution: Changes or modifications not expressly approved by the manufacturer could void the user's authority to operate this device.

CAN ICES-3 (B)/NMB-3(B)

EU COMPLIANCE INFORMATION:

Eligible to bear the CE mark; Conforms to European Union Low Voltage Directive 2006/95/EC; European Union EMC Directive 2004/108/EC; European Union Restriction of Hazardous Substances Recast (RoHS2) Directive 2011/65/EU; European Union WEEE (recast) Directive 2012/19/EU; European Union Radio and Telecommunications Terminal Equipment (R&TTE) Directive 1999/5/EC.

WEEE NOTICE:

	<p>This appliance is labeled in accordance with European Directive 2012/19/EU concerning waste of electrical and electronic equipment (WEEE). This label indicates that this product should not be disposed of with household waste. It should be deposited at an appropriate facility to enable recovery and recycling.</p>
---	--

Table of Contents

Chapter 1: Introducing Your New N2400 Series Devices	6
Product Overview	6
Hardware Overview	6
Chapter 2: Installing and Configuring Your AV Equipment	9
Installation Overview	9
Mounting Options	10
Surface and Wall Mounting	10
Rack Mounting	10
Step-by-Step Installation Instructions.....	12
How IP Address Changes Affect Unit Control	17
Changing IP Addresses	18
Option 1: Assigning IP Addresses Individually (using the Settings page)	18
Option 2: Assigning IP Addresses to Multiple Units (using CSV files)	18
Switching and Scaling Options.....	20
Seamless Switching	20
Control Options.....	21
Primary Control Options.....	21
N-Command Controllers.....	21
Third-Party Controllers	21
N-Act On-Board, Built-In Control	21
N-Touch Touch Panel Controller	21
NetLinx	21
KVM Configuration.....	22
Basic Setup	22
Chapter 3: Encoder Configuration Options	23
Settings Page	24
Encoder Setup Section	25
Advanced Settings	27
RS232 Settings	29
Effects Settings	29
Network Setup Section.....	30
Status Section.....	30
Change Password Section.....	32
LDAP Section	32
Software Section.....	32
HDMI Pass Thru Settings.....	33
HostPlay Page	34
N-Act Page	36
Serial Page	37
Security Page	38
KVM Page	39
EDID Page.....	40

Logs Page.....	41
LLDP Page	42
NetLinx Page	42
AES67 Page.....	43
Chapter 4: Decoder Configuration Options	44
Settings Page	45
Decoder Setup Section	46
Advanced Settings.....	48
RS232 Settings	50
Effects Settings.....	50
Network Setup Section.....	51
Status Section.....	51
Change Password Section.....	53
LDAP Section.....	53
Software Section.....	53
Audio Downmixer Settings	54
Crop/Pan/Zoom Page	55
LocalPlay Page.....	56
N-Act Page	58
Serial Page	59
Security Page	60
KVM Page	61
EDID Page.....	62
Logs Page.....	63
LLDP Page	63
NetLinx Page	65
AES67 Page.....	66
Chapter 5: Troubleshooting	67
Series Default Local/Host Play Troubleshooting Screens	68
Appendix A: NetLinx Control	71
Introduction.....	71
NetLinx Configuration Using the Unit's Webpage.....	71
Batch Configurations Using N-Able	72
Encoder/Decoder Commands 73	
Native Commands Port 1	73
IR/Serial Send Commands Port 3.....	75
Pass Through Commands	75
IR Port 2.....	76
Serial Port 3	76
Appendix B: Minimum Network Requirements	77

Chapter 1: Introducing Your New N2400 Series Devices

Product Overview

The N2400 AV over IP Series belongs to the N-Series product family from AMX. This series provides a flexible, feature-rich, and simple-to-deploy digital media distribution and switching solution satisfying the most demanding applications. N-Series video over IP Encoders are used to encode and distribute sources of almost any format onto an existing IP network, making that stream available to any endpoint in the facility. Video over IP Decoders are used to decode N-Series Networked audio/video (AV) streams back to HDMI or DVI format for display on any monitor. With the ability to direct any source stream to any display, large, low-cost switching and distribution systems are simple to deploy without proprietary cabling or dedicated switching hardware. Plug-n-play, auto-detect technology reduces installation and programming time.

Features include:

- Output Scaling – scaling performed in Decoders for maximum flexibility.
- Power over Ethernet (PoE+) eliminates the need for a local power supply and speeds installation. Units can still be powered locally by 12VDC. This allows easy rack-mountable, high-density installations.
- Active Directory support provided using Lightweight Directory Access Protocol (LDAP).
- Secure command connection provided using Secure Sockets Layer (SSL) and Transport Layer Security (TLS) protocols.
- Infrared (IR) emitter connections allows control of low-cost, IR-only display devices. IR input captures and transmits over the network to units with IR emitters (IR receivers and emitters required).
- Fast install with Phoenix connectors for power, IR, RS232 serial, and analog audio interfaces.
- Pass-through HDMI interface allows easy installation with local display, such as desktop PC applications.
- USB-A and USB Mini-B connections for KVM applications.
- Native NetLinx support provided. NetLinx Studio will easily recognize the device.

Hardware Overview

Refer to the following figures (front and rear panel drawings of these devices) and the [Front and Rear Panel Descriptions table](#) on page 7 for hardware details.

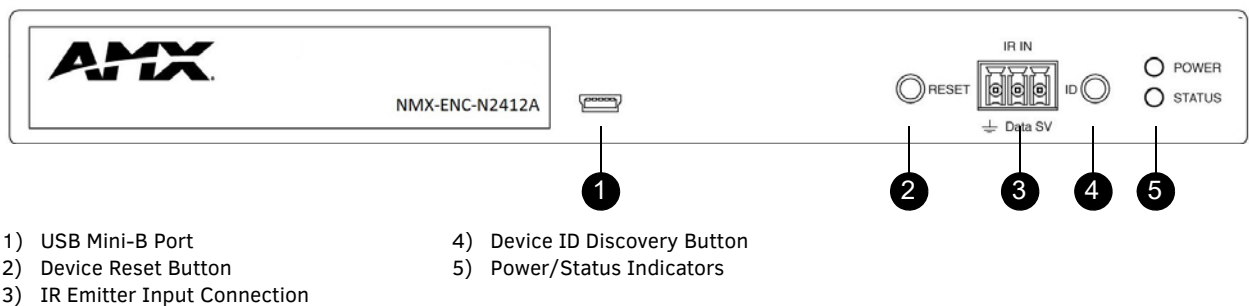

FIG. 1 N2412A Encoder Front Panel

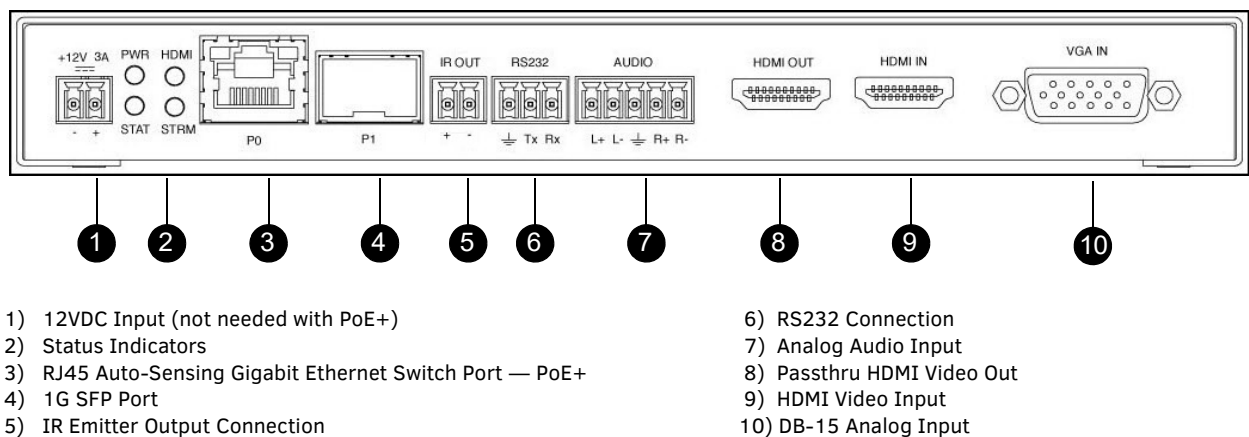

FIG. 2 N2412A Encoder Rear Panel

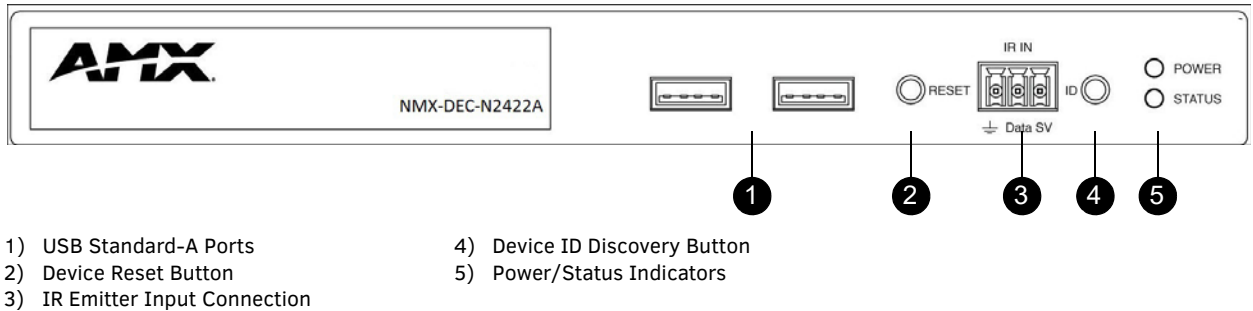

FIG. 3 N2422A Decoder Front Panel

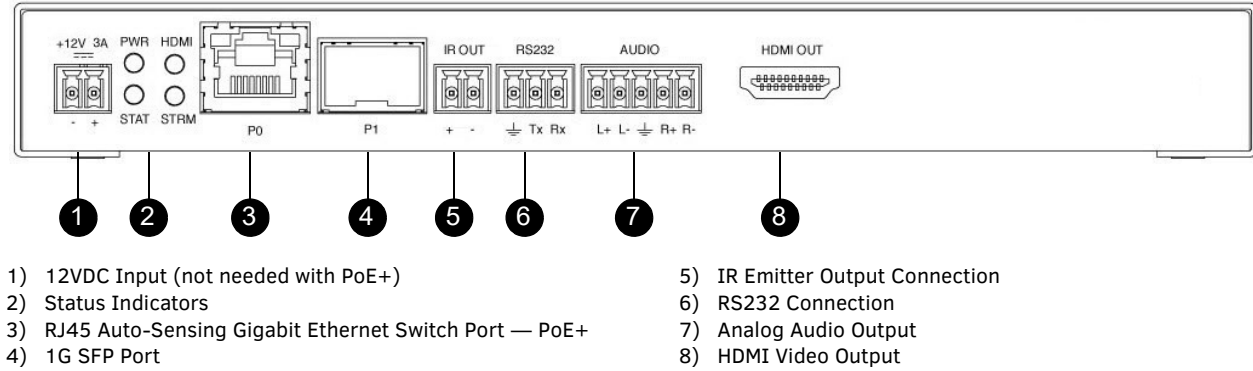

FIG. 4 N2422A Decoder Rear Panel

Front and Rear Panel Descriptions	
Front Panel	
USB Mini-B port	For KVM support. Connects the Encoder to the computer to be controlled.
USB Standard-A port (x2)	For KVM support. Connects the Decoder to keyboard and/or mouse.
RESET button	Recessed pushbutton. Press to initiate a “warm restart” which causes the processor to reset, but not lose power. A reset does NOT affect the current settings.
IR IN	3-pin terminal Phoenix connector. Provides infrared (IR) input only and passes signal back to the connected Encoder/Decoder (33-60 kHz; typically 39 kHz). IR receiver required (not included).
ID button	Recessed pushbutton. Press to send notification out on the network to identify the unit (the notification causes a pop-up dialog in N-Able and N-Command). Press and hold until the STATUS LED extinguishes completely (approximately 45-60 seconds) to initiate a factory restore.
POWER LED	On solid (green) when operating power is supplied (via PoE+ or local power supply). This activity is also shown by the PWR LED on the rear panel.
STATUS LED	On flashing (green) when there is software activity. This activity is also shown by the STAT LED on the rear panel.
Rear Panel	
+12V 3A	12 Volt DC power input.
PWR LED	Same as POWER LED described above.
HDMI LED	On (green) when an HDMI connection exists.
STAT LED	Same as STATUS LED described above.
STRM LED	On (green) when the unit is streaming video.
P0 (PoE+ port)	8-wire RJ45 female. 10/100/1000 Mbps 10/100/1000Base-T auto-sensing gigabit Ethernet switch port. Provides both the network connection and the power to the Encoders and Decoders.
P1 port	1G SFP port which accepts compatible fiber transceivers or direct attach cables (copper or fiber). Modules sold separately.
IR OUT	2-pin terminal Phoenix connector. Provides IR output only (33 to 60 kHz; typically 39 kHz). An IR emitter is necessary (not included).
RS232	3-pin terminal Phoenix connector which provides a serial control interface. Full duplex communication. Available terminal speed settings: 1200 to 115200 baud rate.

Front and Rear Panel Descriptions (Cont.)	
AUDIO	5-pin terminal Phoenix connector which provides user-selectable balanced/unbalanced, dedicated audio input (for Encoders) and output (for Decoders).
HDMI IN	HDMI video input. <i>*Applies to Encoders only.</i>
HDMI OUT	HDMI video output (Decoders). Passthru HDMI video (Encoders).
VGA IN	DB-15 analog input. Allows for the use of analog video sources. <i>*Applies to Encoders only.</i>

Chapter 2: Installing and Configuring Your AV Equipment

This chapter provides an installation overview as well as a detailed step-by-step process for installation. If you encounter any problems, refer to the [Troubleshooting section on page 67](#) for help.

Installation Overview

The N2400 Encoders and Decoders have multiple configuration and installation options. For basic installation guidelines, see the table below. For more detailed instructions, refer to [Step-by-Step Installation Instructions on page 12](#).

Basic Installation Guidelines	
Connections	Options
Power	Power over Ethernet (PoE+): Connect the unit's P0 port to an active, PoE+ enabled network switch.
	External power supply: If not using PoE+ for power, connect a 12V regulated power supply (part number FGN9313) to the unit's two-pin terminal block plug connector labeled +12V 3A.
Network	PoE units: If using PoE+ to power the unit, you should already have a network connection.
	Externally powered units: If not using PoE+, connect either the P0 or P1 port to the network using the appropriate cable.
	Daisy-chain configuration: Once network connection is established to one unit, you can daisy-chain additional units by connecting Ethernet cables between devices using their P0 and/or P1 ports. Keep in mind that the number of units supported in this configuration is limited by bandwidth (total aggregate streams must be less than 1 Gb/s). NOTE: <i>PoE+ power is only supplied to the unit connected directly to the network. All other units in the daisy-chain must have an external power supply.</i>
Video	N2412A Encoders <ul style="list-style-type: none"> For video encoding of a <i>digital</i> source, connect the source to the Encoder's HDMI IN port using a video cable with an HDMI connector (or adapter). For video encoding of an <i>analog</i> source, connect the source to the Encoder's VGA IN port using a video cable with a VGA connector (or component adapter). For local viewing of pass thru video, connect a digital display to the Encoder's HDMI OUT port using a video cable with an HDMI connector (or adapter).
	N2422A Decoders <ul style="list-style-type: none"> For video decoding, connect a digital display to the Decoder's HDMI OUT port using a video cable with an HDMI connector (or adapter).
Audio	N2412A Encoders <ul style="list-style-type: none"> For audio encoding, connect a line level analog audio source to the Audio input terminal block plug connector, or Use the HDMI audio embedded with the source connection. NOTE: <i>Unit will not pass audio from the analog AUDIO input through the pass thru (HDMI OUT) port.</i>
	N2422A Decoders <ul style="list-style-type: none"> For audio decoding, connect a line level analog audio device to the Audio output terminal block plug connector, or Send the HDMI embedded audio to a connected display's speakers.

NOTE: *When the unit is not in use, remove the power cable and disconnect any other cables (e.g., Ethernet, audio, video) connected to the Encoders and Decoders.*

Acceptable Input/Output Types	
N2412A Encoder - Input	
Digital	HDMI - Native connection. No adapter necessary. DVI - Appropriate passive adapter required. DisplayPort- Appropriate passive adapter required. Active adapter required for some sources.
Analog	VGA - Native connection. No adapter necessary. Component- Appropriate passive adapter required. RGBHV- Appropriate passive adapter required.
N2422A Decoder - Output	
Digital	HDMI - Native connection. No adapter necessary. DVI- Appropriate passive adapter required. DisplayPort - Appropriate ACTIVE adapter required. The N2422A will not output DisplayPort through a passive adapter.
NOTE: <i>For all other input/output types, an active adapter is required.</i>	

Mounting Options

The N2400 units are available in stand-alone and card versions. The stand-alone version can be free standing, surface mounted, wall mounted, or rack mounted. All cards *must be rack mounted* using the N9206 Card Cage (sold separately).

Surface and Wall Mounting

To mount your N2400 stand-alone unit to a flat surface or wall, follow these steps:

1. Remove the four screws from the bottom of the unit and use them to attach the mounting wings (not included in shipment - part number N9101). See [Figure 5](#).
2. Place the unit against the solid surface to which you want it mounted.
3. Using standard hardware, attach the unit through each of the slots of the newly-attached mounting wings.
4. Connect the appropriate cables necessary for your application. Refer to the sections : *Connecting Decoders to the Network* on page 14 and : *Connecting Encoders to the Network and Configuring Stream Settings* on page 15 for more information on these connections.

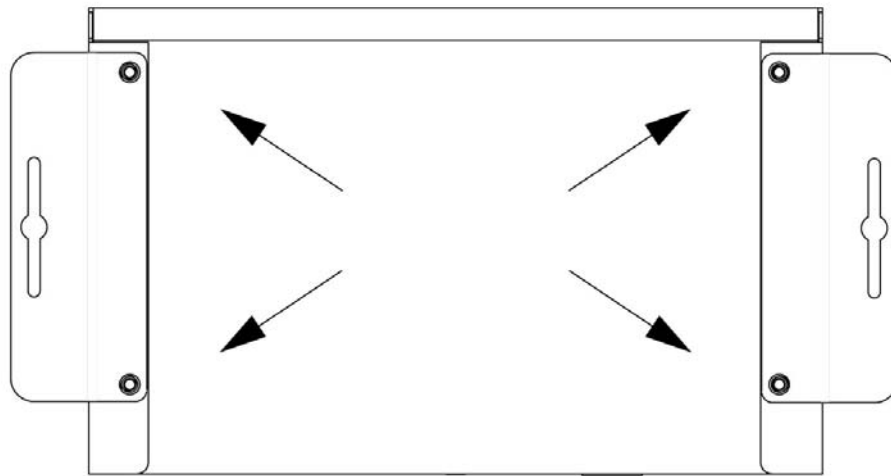

FIG. 5 Installing Mounting Wings

Rack Mounting

N2400 Series Stand-Alone Units

A Rack Shelf (part number N9102) accommodates up to two stand-alone N-Series Encoders or Decoders, side by side (mix and match).

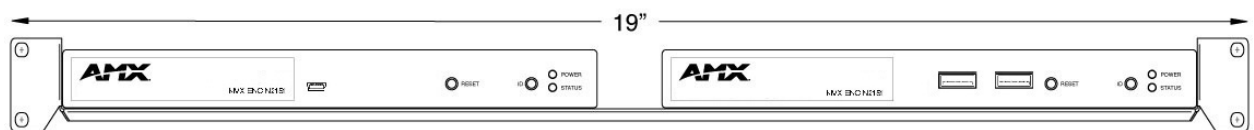

FIG. 6 Rack Mounting Stand-Alone Units

N2400 Series Cards

A Card Cage (part number N9206) accommodates up to six N-Series Encoder/Decoder cards (mix and match). The 12V power supply of the N9206 is the primary power source for the installed cards. If the 12V power supply fails or is unplugged, the cards will power down, detect PoE+ (if provided by switch) and restart normally using PoE+. This usually results in a power loss of about one to two seconds. The unit then reboots (which takes another one to two minutes).

To rack mount N2400 Series cards into the N9206 Card Cage, follow these steps:

1. Gently slide the card into cage slot. Make sure the card is properly aligned with guides. The card's front LED indicators should align with holes in the cage's faceplate. See [Figure 7](#).

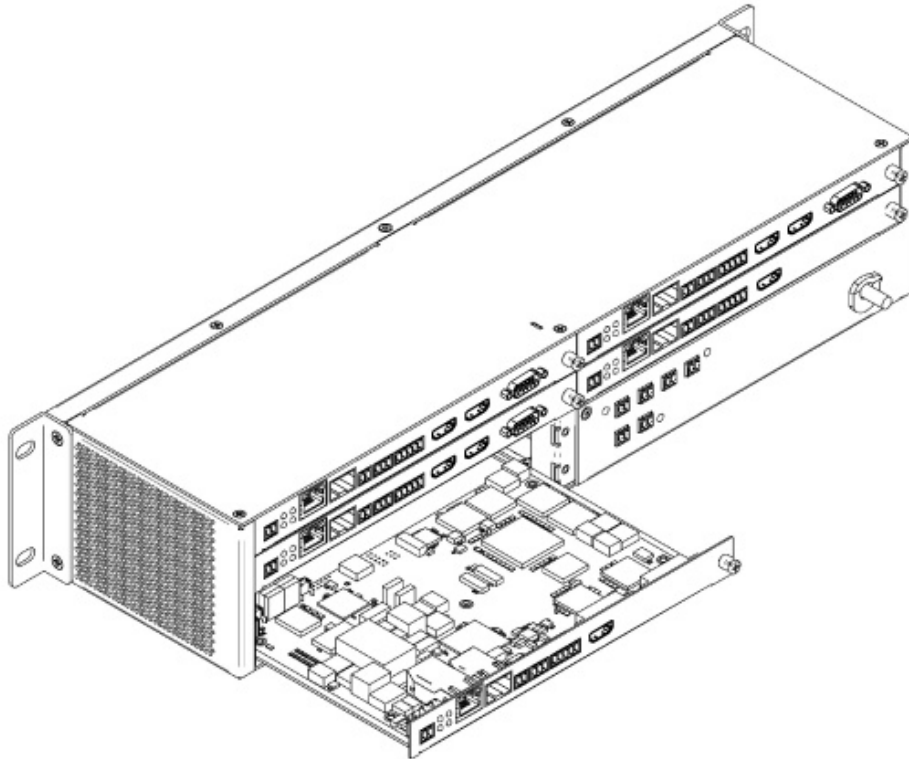

FIG. 7 Rack Mounting Cards

2. Align the thumb screw on back plate before seating card into cage.
3. Firmly seat the card and tighten the thumb screw by hand to secure card placement.
4. Use one of the six Phoenix connector cables (included in shipment with the Card Cage) to connect the card's 12VDC input Phoenix connector to one of the cage's six 12VDC outputs.
5. Repeat these steps until all cards are properly installed. See [Figure 8](#).

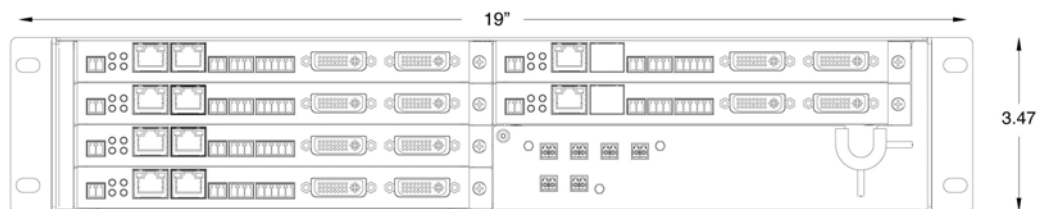

FIG. 8 Fully-Populated Card Cage

6. For proper airflow, cover any unused card slots with faceplate blanks. Blanks are sold separately (part number N9210).
7. Make sure the Card Cage's power cord is plugged in for proper cooling.

CAUTION: Keep the Card Cage's power cord plugged in at all times so that the internal fans are always running. Not doing so could void the warranty of the cage and all installed cards. Fans are not powered while in backup PoE power mode. Please remedy power losses immediately to avoid potential overheating hazards.

NOTE: Mounting accessories are sold separately and are compatible with most N-Series devices. Contact a sales representative or visit our website for details.

Step-by-Step Installation Instructions

This section provides step-by-step guidance for installing and configuring equipment from the N-Series product family on your network. The steps provided here assume the following to be true:

1. *There are switches operational on the network.*
N-Series equipment can operate on many different brands of networking equipment. The network itself needs to meet certain requirements to be able to support deployment. These instructions assume that you have purchased and installed a pre-configured switch from AMX or that your existing equipment meets the following physical and protocol requirements:
 - Layer 2 (with IGMP Multicast Protocol), OR Layer 3 (also known as “multi-layer”)
 - Gigabit Ethernet
 - IGMP Snooping
 - IGMP Snooping Querier (which only needs to be enabled on a single switch within the network)

NOTE: To proceed with this installation, the switches must already be successfully connected to your network. If needed, refer to your product’s documentation for installation instructions.
2. *Deployment considerations have been made for the addition of high-speed video.*
Our Networked AV solutions provide unsurpassed video and audio quality at bandwidths appropriate to any network segment or link. Matrix switches as large as 1200x800 have been constructed on a house network using N-Series equipment. Alternatively, many customers choose to deploy on physically separate networks in order to use low-cost network appliances but keep video traffic separate from data and voice.
3. *N-Able software (version 2017.02.02 or higher) has been loaded on the computer you are using to configure the equipment.*
From your host computer, download N-Able (our free setup utility software):
PC version - <http://www.amx.com/products/N-ABLE-PC.asp>
Mac version - <http://www.amx.com/products/N-ABLE-MAC.asp>
This software is designed to set up and control the equipment during initial deployment, however, it is not always the best solution for production-type or primary user control. Refer to [Control Options on page 21](#) for details on the available control options.

NOTE: For a more detailed requirements list, refer to [Appendix B: Minimum Network Requirements on page 77](#).

NOTE: N-Able and N-Command products include software developed by the OpenSSL Project for use in the OpenSSL Toolkit (<http://www.openssl.org/>).

Step 1: Setting Up Your Host Computer

In order to communicate with N-Series products, your devices must be on the same subnet as the host computer. N2400 units are shipped in **DHCP** mode and the IP address will be assigned automatically based on the network DHCP server. If no DHCP server is found, the unit will use **Auto IP** mode with a default IP address of 169.254.xxx.xxx.

Before beginning installation, you may need to make some changes to the computer running N-Able. These steps show how this can be accomplished in a Microsoft Windows environment.

1. From the **Start** menu, select **Control Panel > Network and Sharing Center**.

2. Select **Change adapter settings**.

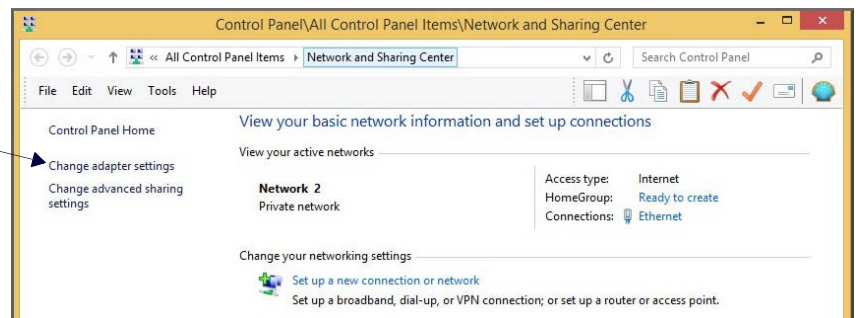

3. Double-click the wired interface to your AV network, and then click the **Properties** button.

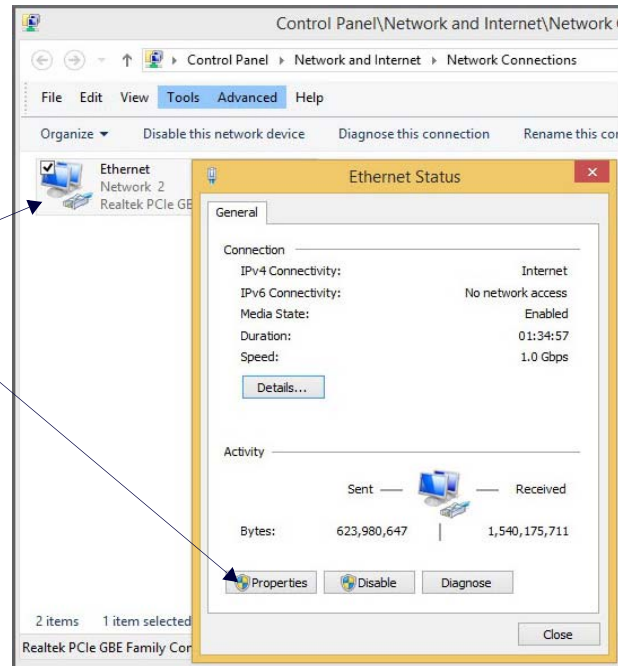

4. Scroll down in the list to the **Internet Protocol Version 4 (TCP/IPv4)** option. Highlight it and click the **Properties** button.

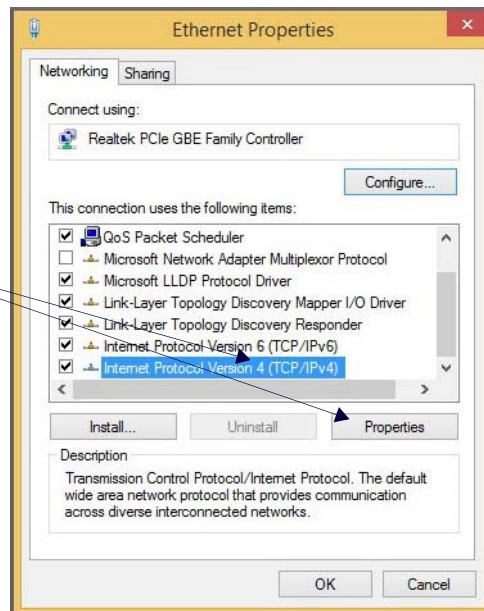

5. Enable the **Use the following IP address** option, and enter the static IP address provided to you by your network administrator.

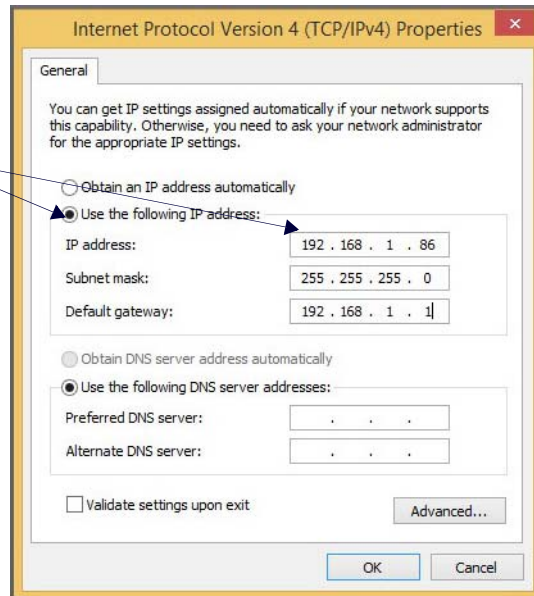

NOTE: If the computer does not need Internet access, you can simply enter a unique 169.254.xxx.xxx IP address with a 255.255.0.0 subnet mask. Contact your network administrator if you are unsure of how to configure the existing network. N-Series units will not self-assign in the 169.254.xxx.xxx range.

NOTE: If the computer has a statically-assigned IP address, click the *Advanced* button. Then click *Add* to enter a unique 169.254.xxx.xxx address with a Subnet Mask of 255.255.0.0 and a Default Gateway of 169.254.1.1.

Step 2: Connecting Decoders to the Network

The digital connection from a Decoder **HDMI OUT** port (female) to a display is accomplished using either an HDMI cable or DVI-D (through adapter). N2400 units support embedded audio input and output on the HDMI ports; however, some display devices (e.g., many monitors) *do not* support embedded audio. When using such a display, use the **AUDIO** port for separate transmission of sound and turn **HDMI Audio Enable** off (on the **Settings** page) to avoid video display issues.

Power is supplied via a PoE+ enabled switch or an external power supply. Refer to the following steps and [Figure 9](#) for guidance.

- Using a Cat-5 cable, connect your N-Series Decoder's **P0** port to a PoE+ enabled switch. This provides both network and power connection. In non-PoE applications connect a 12V regulated power supply (FGN9313) to the two-pin terminal block plug connector (labeled **+12V 3A**).
- Connect the display you would like to use for that Decoder (monitor, projector, etc.) to the Decoder's **HDMI OUT** port using an HDMI cable (or DVI through adapter). This must be a digital video connection.

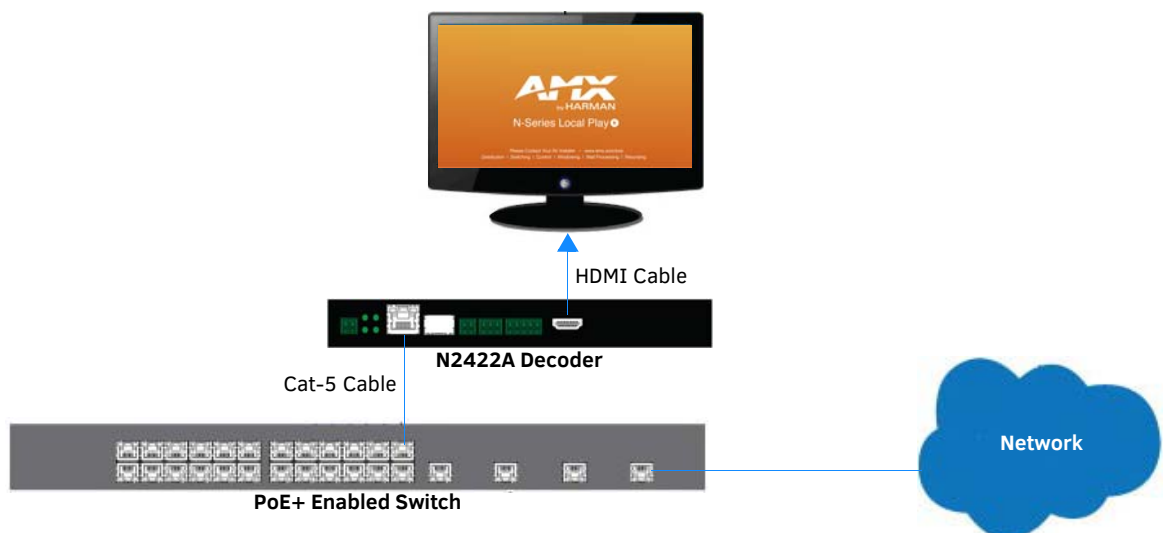

FIG. 9 Decoder Connections

- Repeat Steps 1 and 2 until all Decoders are installed on the network.
- Once the Decoders and displays are connected and powered up, the LocalPlay screen appears on the displays.

NOTE: If the LocalPlay screen does not appear, refer to the chapter *Troubleshooting* on page 67 for more guidance.

NOTE: In order for the unit to receive PoE+, it must be connected to a switch or other equipment that has a PoE+ PSE (Power Sourcing Equipment) port. PoE+ does not pass through the daisy chain (P1) port.



CAUTION: Do not run wiring that is connected to a PoE+ PSE port outside of the building where the PSE resides. It is for intra-building use only.

Step 3: Connecting Encoders to the Network and Configuring Stream Settings

- Using a Cat-5 cable, connect your N-Series Encoder's **P0** port to a PoE+ enabled switch. In non-PoE applications connect a 12V regulated power supply (FGN9313) to the two-pin terminal block plug connector (labeled **+12V 3A**).

NOTE: In order for the unit to receive PoE+, it must be connected to a switch or other equipment that has a PoE+ PSE port.

- In **N-Able**, select the **Unit Management** tab and click the **Auto Discover** button (if the table has not already populated itself with the installed units). See [Figure 10](#).

	Name	Type	MAC	IP	SN	Streams	Mode	Resolution	Audio
1	ROOM 3 TV 4	N2400 Decoder	00:19:0B:80:21:64	169.254.146.73	N2422A30001115	145	Live Play	1080p60	On (Follow)
2	ROOM 6 TV 2	N2400 Decoder	00:19:0B:80:20:5E	169.254.134.105	N2422A30000858	200	Live Play	1280x720	On (Follow)
3	Front Display	N3000 Decoder	00:19:0B:80:2A:A9	169.254.187.39	N3232A20000221	526	Live Play	720p60	On (Follow)
4	Back Display	N3000 Decoder	00:19:0B:80:14:41	169.254.87.3	N322A030000231	526	Live Play	720p60	On (Follow)
5	2151 Latency Tester	N-Series 4K Encoder	00:19:0B:80:02:26	169.254.40.104	N215A020000183	U:1555,C:555	Live Play	0x8191	On
6	Podium 3 Computer	N2400 Encoder	00:19:0B:80:06:4C	169.254.163.76	N2412A30000143	200	Live Play	1280x720	On
7	Conference Room 42	N2400 Encoder	00:19:0B:80:06:48	169.254.220.199	N2412A30000139	145	Live Play	1080p60	On
8	Network Media N3000 Enc	N3000 Encoder	00:19:0B:00:23:D5	192.168.1.88	N312A040000413	213	Live Play	1080p60	On
9	Camera 45	N3000 Encoder	00:19:0B:80:1F:36	169.254.144.255	N3132A20000196	8754	Live Play	720p60	On
10	Camera 23	N3000 Encoder	00:19:0B:80:1F:22	169.254.7.6	N3132A20000176	34	Live Play	720p60	On
11	Lobby NVR	Network Video Recorder	00:19:0B:E0:00:96	169.254.251.182	VDA000000174	(2255,2233),(2510,300)	idle,idle		On (Follow,Follow)
12	NCMD-MAC-0103	N-Command N8000	00:19:0B:F0:01:03	192.168.1.37 / 169.254.10.37	NCMD-MAC-0103				
13	NCMD-MAC-017F	N-Command N8000	00:19:0B:F0:01:7F	192.168.1.237 / 169.254.20.189	NCMD-MAC-017F				
14	NCMD-MAC-01A1	N-Command N8000	00:19:0B:F0:01:A1	192.168.1.242 / 169.254.10.10	NCMD-MAC-01A1				

FIG. 10 Unit Management Page

- Find your Encoder in the list. N2400 units are displayed on the following tabs:
 - Unit Management** tab — N2400 units have **N2400 Encoder/Decoder** listed in their **Type** fields.
 - Video Matrix** tab — N2400 units are found on the **N2400** sub-tab (as shown in [Figure 11](#)).

NOTE: If using multiple Encoders in your set up, it is important to plug in and configure one Encoder at a time. As you add Encoders to the network, you will need to set them up to use different streams.

Encoders are listed across the top of the page.

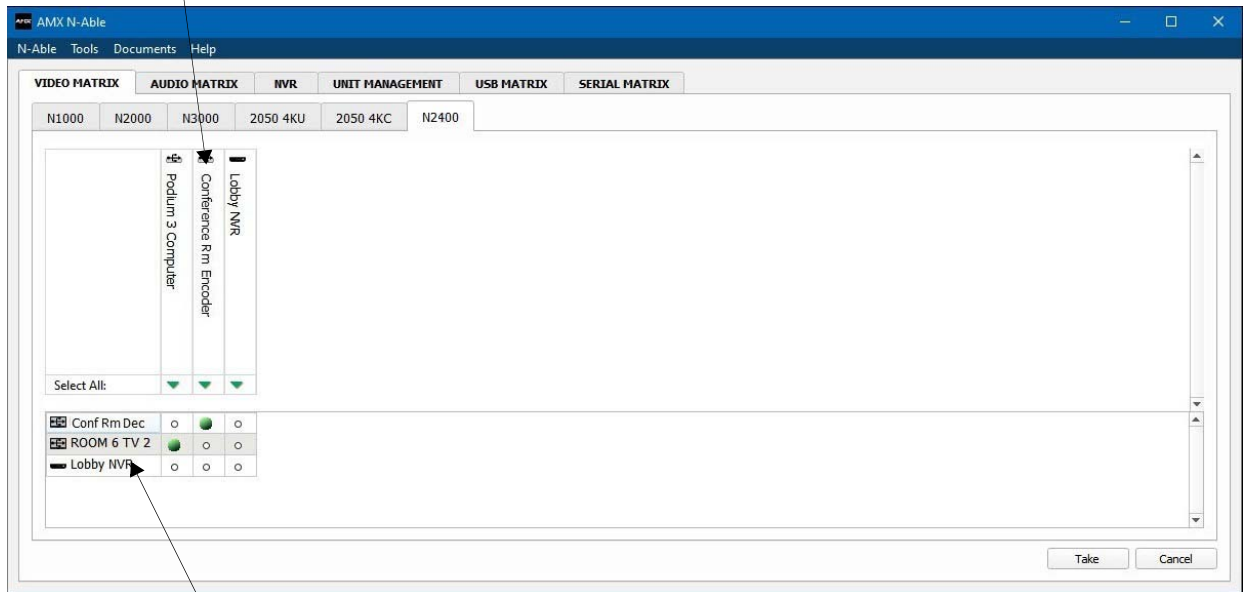

Decoders are listed down the left side of the page.

Red Text - No video source (Encoder) or no display (Decoder).

Red Exclamation Point (!) - N-Able cannot communicate with device.

Gray Text - Video network transmit for this unit is disabled.

Black Text - Unit is in live play mode.

Blue Text - Unit is playing locally-stored content.

FIG. 11 Video Matrix Page

- Double-click the Encoder's name in the list. If prompted, use the following default login credentials to log in for the first time (see [Figure 12](#)). These can be changed later on the **Settings** page.

Default username: **admin**

Default password: **password**

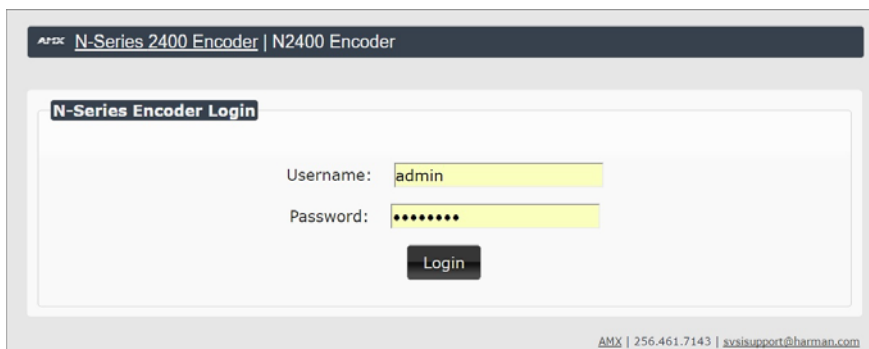

FIG. 12 Login Page

NOTE: The Login page is only displayed if N-Able's stored username/password does not match the unit's username/password. A default system will match.

- The **Settings** page is displayed (see [Figure 13](#)).
- Change the **Stream** setting. We recommend setting **Stream** to a unique number between 2 and 254 (it is *required* that the number be less than 32,512).

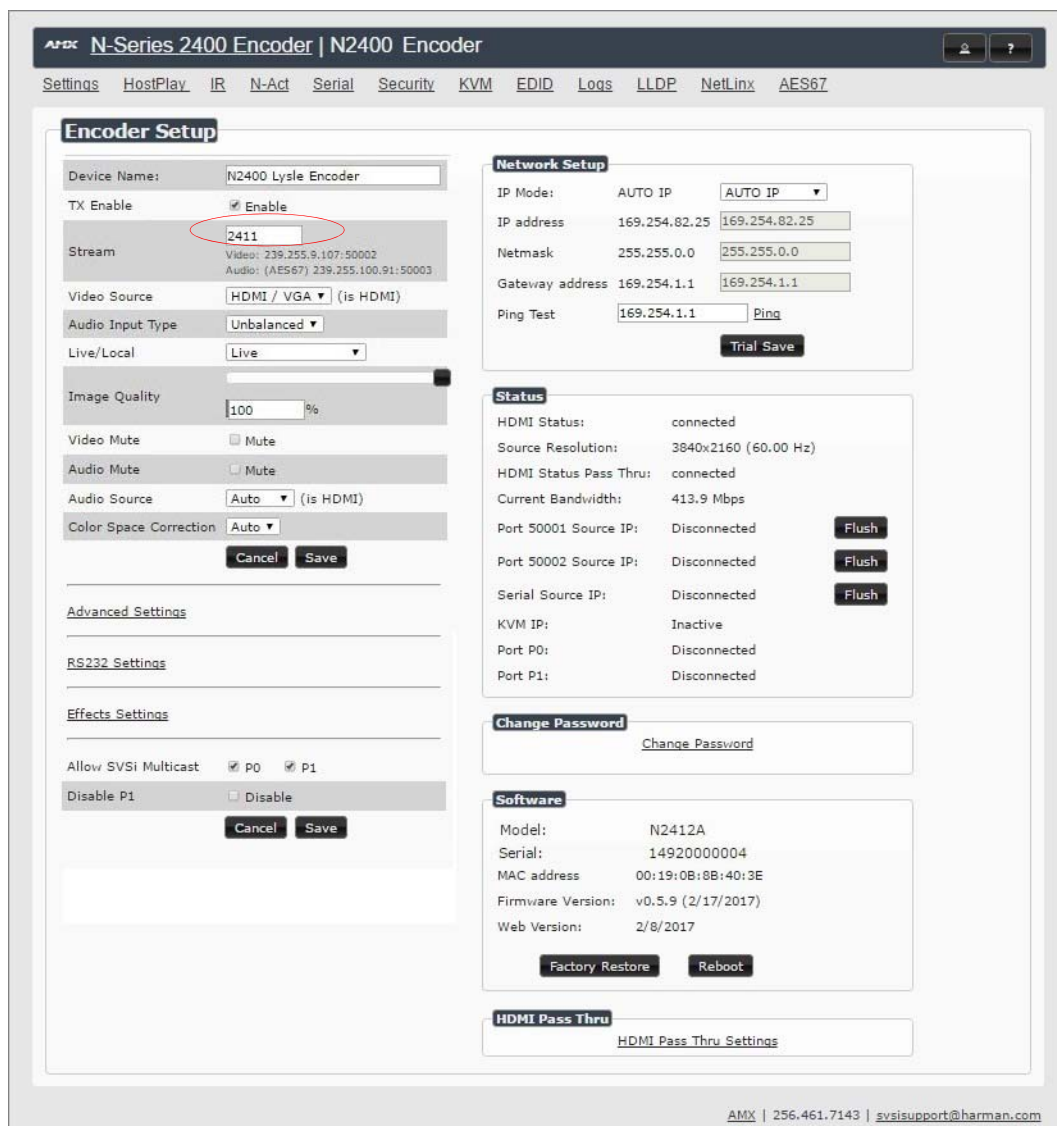

FIG. 13 Changing Stream Setting

7. Repeat these steps until all Encoders are connected to the network and configured with an appropriate **Stream** number.

NOTE: Each Encoder's Stream number must be unique to all other Encoders on the network.

NOTE: Screen-by-screen descriptions of the web interface options are provided for your reference in the Encoder Configuration Options section on page 23 and the Decoder Configuration Options section on page 44.

Step 4: Configuring Decoder and Encoder IP addresses (if needed)

By default, all Decoders and Encoders are preset to **DHCP** mode. When first connected to the network, an IP address is assigned automatically based on the network DHCP server. If no DHCP server is found, the unit will use **Auto IP** mode (with an IP address pre-configured to 169.254.xxx.xxx with a subnet mask of 255.255.0.0).

How IP Address Changes Affect Unit Control

As discussed previously, N-Able control is dependent upon the host computer being in the same IP address range as the N-Series devices. Therefore, before making any N2400 IP address changes, we recommend having **two statically-assigned IP addresses on your computer**.

- Configure the first IP address to be in the range of the default N-Series IP settings (i.e., in the 169.254.xxx.xxx range), AND
- Configure a second IP address in the range of the IP address you are planning to assign to the units (or when using DHCP, an address within the defined range for your network).

Changing IP Addresses

There are two ways to assign new IP addresses to your N2400 units using N-Able:

- **Option 1:** Log in to each unit individually and make the changes on the **Settings** page.
- **Option 2:** Export a comma-separated value (CSV) file, make changes to all units in the resulting file, and import the CSV file into N-Able to apply the changes.

Option 1: Assigning IP Addresses Individually (using the Settings page)

1. Find the unit you wish to change in the control matrix (either on the **Unit Management** tab or the **Video Matrix > N2400** tab).
2. Double-click the unit and log in.
3. Go to the **Settings** page and make IP address changes for that unit either by setting a **STATIC** address or by enabling **DHCP** (see [Figure 14](#)).

The screenshot shows a 'Network Setup' form with the following fields and values:

IP Mode:	AUTO IP	AUTO IP
IP address	169.254.82.25	169.254.82.25
Netmask	255.255.0.0	255.255.0.0
Gateway address	169.254.1.1	169.254.1.1
Ping Test	169.254.1.1	Ping

A 'Trial Save' button is located at the bottom center of the form.

FIG. 14 Network Setup Section of the Settings Page

4. Click the **Trial Save** button.
5. Return to the **Settings** page through the newly-configured IP address.
6. Once the **Settings** page appears (successfully using the new IP address) click the **Confirm** button to lock in your changes.

NOTE: If you lose communication for any reason, unplug the N2400, wait one minute, and plug it back in. This restores the unit to the original IP address.

Option 2: Assigning IP Addresses to Multiple Units (using CSV files)

N-Able has the ability to export and import CSV files. Once units are auto-discovered in N-Able, the CSV file can be exported into Excel where parameters such as IP address, subnet mask, gateway, stream number, audio settings, etc. can be configured. Once configured, import the CSV file back into N-Able to assign those parameters to the appropriate devices. Reboot the devices to activate the new settings. This procedure can be used to configure multiple networked AV devices at the same time. It can also provide valuable diagnostics by allowing you to see the last known device configuration as well as scan the network for new devices (regardless of IP configuration).

To configure units using a CSV file, follow these steps:

1. Make sure that you have performed an **Auto Discover** (on the **Unit Management** tab of N-Able) since connecting all of the new units to the network.
2. From N-Able's main menu bar, select **N-Able > Export CSV**.
3. Click **Yes** on the pop-up box informing you that a CSV file is about to be generated.

NOTE: A CSV file editor (e.g., Microsoft Excel) is necessary to proceed.

4. The folder containing your CSV file displays. Double-click the file to open it.
5. You can use this file to edit the IP mode, IP address, subnet mask, gateway IP address, stream number, etc. Once all changes have been made, save the file.
6. Go back into N-Able and select **N-Able > Import CSV**.
7. Browse to your saved CSV file and click **Import**.

Step 5: Connecting Encoders to an Input Source

Having already connected the Encoder(s) to the network and made the appropriate settings changes (as described in [Step 3](#) and [Step 4](#)), you can now connect to the appropriate AV source(s). This connection from an Encoder **HDMI IN** port (female) to an input source is accomplished using either an HDMI cable or DVI-I (through adapter).

1. Connect the source you would like to use for the Encoder (camera, laptop, etc.) to the Encoder's **HDMI IN** port using an HDMI cable. This connection can be digital or analog.
2. Repeat until all Encoders are connected to their sources.

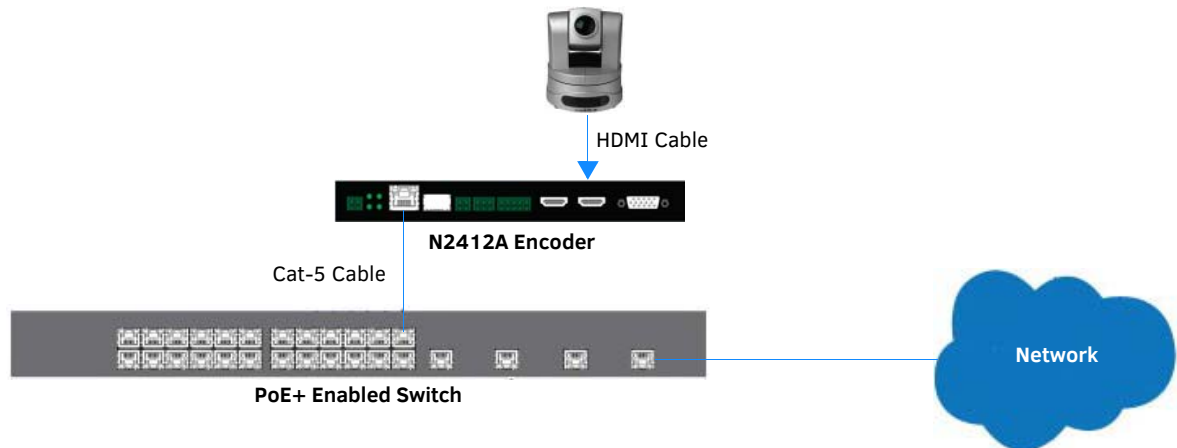

FIG. 15 Encoder Connection to Source

Switching and Scaling Options

N-Series Encoders and Decoders make up a true AV matrix solution. In other words, one input can go to any or all outputs. Decoders have internal scaling capabilities. Keep the following in mind:

- The input of an Encoder is the video and/or audio signal going into the Encoder.
- The output of an Encoder is the network stream.
- The input of a Decoder is the network stream.
- The output of a Decoder is the digital video and/or audio being transmitted out to the display device.
- Upscaling and downscaling are fully supported.

Seamless Switching

The N2400 Series supports seamless switching capability if the scalers in the Decoders are enabled. If the scalers are off, all of the *sources* must have the same resolution and refresh rate of the Encoder.

To get streams onto a Decoder, use the **Video Matrix** tab to route video from an Encoder to a Decoder. This works seamlessly if the previously mentioned settings are true. All you have to do is click the common cell on the matrix, and click the **Take** button. See [Figure 16](#) for an example.

Enabling this cell causes the Decoder named **Conf Rm Dec** to listen to the Encoder named **Conference Rm Encoder**.

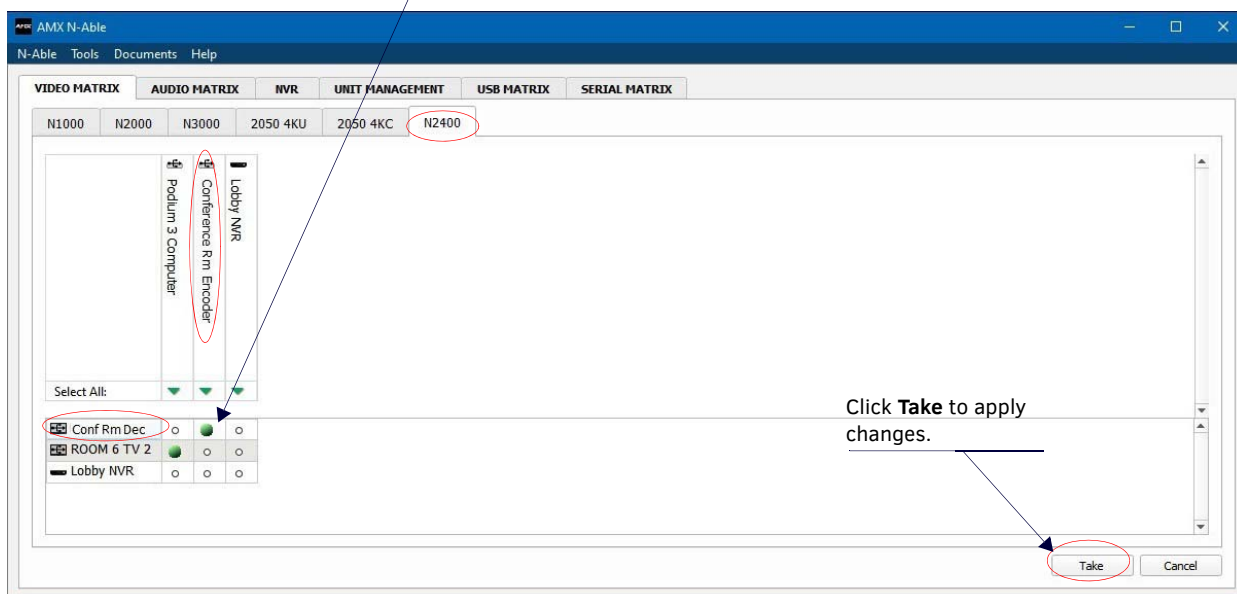

FIG. 16 Seamless Switching Using the Video Matrix

Control Options

For the most part, once the initial setup is complete, you will be primarily managing/configuring the Decoders. To better understand, think of Encoders as radio stations and Decoders as car radios. The Encoders are supplying the streams and, using the Decoders, you can “tune in” to the stream you want. N-Series’s N-Control solutions (N-Command, N-Act, and N-Touch) provide you with the most flexible management options available, insuring you are getting the most from your digital media system.

NOTE: *N-Able and N-Command products include software developed by the OpenSSL Project for use in the OpenSSL Toolkit (<http://www.openssl.org/>).*

Primary Control Options

During initial configuration and setup, the free N-Able setup utility (version 2016.11.11 or higher) is sufficient. However, we do not recommend N-Able for production-level, primary-user control.

N-Command Controllers

These web-based hardware Controllers offer intuitive, powerful management of equipment, content, NVR recording/playback, bandwidth utilization, and AV switching (using a web-based, point-and-click graphical matrix). The N-Command product line also offers:

- Simplified ASCII interface for third-party control via TCP/IP.
- N8002 and N8012 controllers have master/slave failover protection.
- N8012 controller has hot-swappable drives and redundant power supplies.
- Graphical presentation of video network connections.
- Full configuration control: assign fixed IP addresses for each N-Series component, adjust variable bit-rate for each video stream, etc.
- Additional software bundles (free with N-Command) allow you to easily create attractive touch panels for N-Series and third-party equipment control, as well as build software design walls of any size. Visit our website for more details on the available N-Command Controllers.

Third-Party Controllers

The N2400 Series is capable of interfacing with third-party control systems. For direct control of N2400 units from any Third Party Control system, please use the Direct Control API (available on our website).

N-Act | On-Board, Built-In Control

All N-Series Encoders and Decoders have on-board, built-in control capability via events that can trigger any number of TCP/UDP commands to other IP controllable devices. Included free with all N-Series Encoders/Decoders. See the section [N-Act Page on page 36](#) for more information.

N-Touch | Touch Panel Controller

The NT-SD-701 and NT-ST-701 N-Touch Panels allow you to easily add a control interface to your N-Series system. Each touch panel combines a high-quality user interface and controller into a single unit, enabling user control of N-Series devices in conference rooms, classrooms, and other types of spaces. Key features include control of network-based devices, a brilliant 24-color depth, and PoE connectivity – all at an economical price point.

NetLinx

NetLinx Studio is commonly used by system programmers to streamline the integration, programming, organization, and support of their AMX equipment. As the cornerstone of AMX’s system design software tools, NetLinx Studio offers programmers the most flexible application capable of generating the most sophisticated code possible. Refer to *Appendix A: NetLinx Control* on page 71 for more information.

KVM Configuration

The N2412A Encoders and N2422A Decoders are KVM-capable. By default, USB connections are disabled.

Basic Setup

Follow these steps for basic KVM configuration:

1. On the N2412A Encoder, connect the USB Mini-B port to the computer to be controlled.
2. Connect the computer's video output to the Encoder's **HDMI IN** port.
3. On the N2422A Decoder, connect the **HDMI OUT** to the display.
4. Connect a USB keyboard and mouse to the Decoder's USB Standard-A ports (they can be plugged into either port).

NOTE: For wireless devices, simply plug the wireless signal receivers into these ports. For keyboard and mouse combos (with a single connection) use the keyboard port.

5. Using N-Able, click the **Unit Management** tab.
6. Click the **Auto Discover** button to discover your new devices (if you have not already done so).
7. Once discovery is complete (and you see the new units listed in N-Able), click the **Video Matrix** tab.
8. On the matrix, click the common cell for the desired Encoder/Decoder streaming combination.
9. Click the **Take** button to make the change to your matrix. The radio button turns green to indicate the connection was successful.
10. Check the **USB Enable** box on the Encoders and Decoders being used (this setting is found on the **KVM** page of the GUI). See *KVM Page* section on page 39 for more details.
11. On the Decoder's **KVM** page, enter the KVM Encoder's IP address (in the **IP Address** field). See *KVM Page* section on page 61 for more details.

NOTE: *Multiaccess is enabled by default, meaning you can have multiple Decoders attached to a single Encoder. Simply go to each Decoder's KVM page and enable USB and input the Encoder's IP address (or create the connection in N-Able, as described in the steps above).*

Chapter 3: Encoder Configuration Options

This chapter defines N2412A Encoder configuration options. For ease of navigation, it is organized to reflect the graphical user interface (GUI).

From any main page in the GUI, you can access all other main pages by clicking the links in the top navigation bar. [Figure 17](#) shows the navigation bar and provides hot links to the sections of this chapter which describe each main page.

[Settings Page](#) on page 24.

[HostPlay Page](#) on page 34.

[IR Page](#) on page 35.

[N-Act Page](#) on page 36.

[Serial Page](#) on page 37.

[Security Page](#) on page 38.

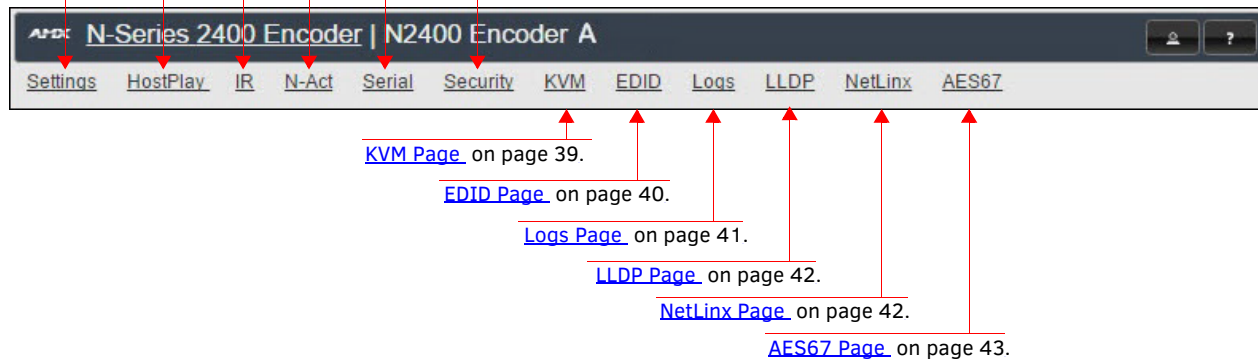

FIG. 17 Section Links

Settings Page

Click the **Settings** link at the top of any of the main web pages to access the page shown in [Figure 18](#). This page is divided into several sections and also has links to other dialog boxes for additional configuration options. Refer to the following sections for detailed descriptions:

- [Encoder Setup Section on page 25](#)
- [Advanced Settings on page 27](#)
- [RS232 Settings on page 29](#)
- [Effects Settings on page 29](#)
- [Network Setup Section on page 30](#)
- [Status Section on page 30](#)
- [Change Password Section on page 32](#)
- [on page 32](#)
- [Software Section on page 32](#)
- [HDMI Pass Thru Settings on page 33](#)

N-Series 2400 Encoder | N2400 Encoder A

Settings | HostPlay | IR | N-Act | Serial | Security | KVM | EDID | Logs | LLDP | NetLinX | AES67

Encoder Setup

Device Name: N2400 Lysle Encoder

TX Enable: Enable

Stream: 2411
Video: 239.255.9.107:50002
Audio: (AES67) 239.255.100.91:50003

Video Source: HDMI / VGA (is HDMI)

Audio Input Type: Unbalanced

Live/Local: Live

Image Quality: 100%

Video Mute: Mute

Audio Mute: Mute

Audio Source: Auto (is HDMI)

Color Space Correction: Auto

Cancel Save

Network Setup

IP Mode: AUTO IP (AUTO IP)

IP address: 169.254.82.25 (169.254.82.25)

Netmask: 255.255.0.0 (255.255.0.0)

Gateway address: 169.254.1.1 (169.254.1.1)

Ping Test: 169.254.1.1 Ping

Trial Save

Status

HDMI Status: connected

Source Resolution: 1920x1080 (60.00 Hz)

HDMI Status Pass Thru: connected

Current Bandwidth: 2.1 Mbps

Port 50001 Source IP: Disconnected Flush

Port 50002 Source IP: Disconnected Flush

Serial Source IP: Disconnected Flush

KVM IP: Inactive

Port P0: Disconnected

Port P1: Disconnected

Change Password

Change Password

Software

Model: N2412A

Serial: 14920000004

MAC address: 00:19:0B:8B:40:3E

Firmware Version: v0.5.10 (2/21/2017)

Web Version: 2/8/2017

Factory Restore Reboot

HDMI Pass Thru

HDMI Pass Thru Settings

AMX | 256.461.7143 | svsisupport@harman.com

FIG. 18 Settings Page

Encoder Setup Section

The **Encoder Setup** section of the **Settings** page is shown in [Figure 19](#). Options are described in [Table 1](#).

The screenshot shows the 'Encoder Setup' configuration window. At the top, the 'Device Name' is set to 'N2400 Encoder'. Below this, 'TX Enable' is checked. The 'Stream' number is '2411', with video and audio details provided. 'Video Source' is set to 'HDMI / VGA', 'Audio Input Type' is 'Unbalanced', and 'Live/Local' is 'Live'. 'Image Quality' is a slider set to 100%. There are checkboxes for 'Video Mute' and 'Audio Mute', both currently unchecked. 'Audio Source' is set to 'Auto' and 'Color Space Correction' is also 'Auto'. At the bottom of this section are 'Cancel' and 'Save' buttons. Below this are three expandable sections: 'Advanced Settings', 'RS232 Settings', and 'Effects Settings'. The bottom section contains 'Allow SVSi Multicast' (checked for P0 and P1) and 'Disable P1' (unchecked), with another set of 'Cancel' and 'Save' buttons.

FIG. 19 Encoder Setup Section

TABLE 1 Settings Page: Encoder Setup Section

Option	Description	Notes
Device Name	Enter a user-friendly name for the unit.	More descriptive names in this field help you organize and manage the N-Series system efficiently. Names based on the unit's location and function are very useful. Some good examples are Lobby-Left-VGA (for left side of lobby, VGA input) or CR201-HDMI (for Conference Room 201, HDMI input). Keep in mind the matrices are organized alphanumerically.
TX Enable	Enable to broadcast the AV signals. Disable to turn off/stop broadcasting.	
Stream	View/edit the current transmit stream number.	To better understand this setting, think of Encoders more like a channel on a cable box, rather than a traditional AV Matrix. Each Encoder must have a unique stream number, just like every channel must have a unique channel number (e.g., Food Network and HGTV cannot both be on channel 201).
Video Source	Select which input port is encoding video.	Selecting HDMI/VGA declares HDMI as the primary port and VGA as the secondary port (when there is no HDMI input). Selecting VGA only or HDMI only disables the other video input port.
Audio Input Type	Select Unbalanced (single-ended) or Balanced analog audio input.	
Live/Local	Select live video or locally stored images for transmission onto the network. When video is not available, it automatically goes into local mode.	When video is not available, the most recently played local playlist is displayed.

TABLE 1 Settings Page: Encoder Setup Section (Cont.)

Option	Description	Notes
Image Quality	Adjust the compression level of the image. The further to the left on the slider, the more compression which will display as pixelization of the image.	
Video Mute	Enable to mute video by outputting solid black.	
Audio Mute	Enable to stop the transmission of audio data onto the network.	
Audio Source	Set the audio source to be disabled, enabled or selected automatically (see note).	The AUTO setting always corresponds to HDMI audio as long as there is an HDMI source. If the source is unplugged, it will automatically fall back to analog audio (if there is an analog source plugged in).
Color Space Correction	Set the color space settings for the Encoder (YcbCr, RGB) to be disabled, enabled, or selected automatically based on the source.	If you see a pink/green washed out screen (across the entire image), this can be changed by modifying color space settings. Most sources function with Auto selected but (for problematic sources) hard-set the value to what the source requires. It is best to do hard-set for all permanently installed sources (e.g., cameras, cable boxes, etc), but leave Auto on for periodic sources (e.g., laptop inputs).
Cancel	Click to return all controls to the last saved configuration.	This button affects all Encoder Setup controls that are listed above it.
Save	Click to accept changes made to the controls.	This button affects all Encoder Setup controls that are listed above it.
Advanced Settings	Refer to Advanced Settings on page 27 for details on the options available from this link.	
RS232 Settings	Refer to RS232 Settings on page 29 for details on the options available from this link.	
Effects Settings	Refer to Effects Settings on page 29 for details on the options available from this link.	
Allow SVSI Multicast	Disable this option to prevent the port from outputting multicast video traffic.	Particularly useful if you are connecting a non-SVSI device (i.e., not an N-Series device) to a port for network-based control.
Disable P1	Completely disables the P1 port for all traffic.	Once disabled, anything connected to the P1 port will no longer be available on the network.
Cancel	Click to return the related controls to the last saved configuration.	This button affects the Allow SVSI Multicast and Disable P1 controls.
Save	Click to accept changes made to the related controls.	This button affects the Allow SVSI Multicast and Disable P1 controls.

Advanced Settings

The section of the **Settings** page shown in [Figure 20](#) is displayed when you click the **Advanced Settings** link. Options are described in [Table 2](#).

Advanced Settings

Input Level Gain Left

Input Level Gain Right

Audio Gain

Audio Gain Left

Audio Gain Right

Microphone bias

Audio Encrypt Enable

Brightness

Horz Offset

Vert Offset

Component Sync Window

Input audio for HostPlay Enable

HostPlay for Unsupported Enable

Gratuitous ARP Enable

ARP Interval(secs)

Unsolicited Status Enable

Send Status Address

Status Interval(secs)

Discovery Packet Transmit Enable

Discovery Interval(secs)

TTL

Video VLAN Tagging Enable

Video VLAN #

DSCP #

Serial Master Enable Enable

Serial Slave Address

IR Command Holdoff ms

IR Repeat Holdoff ms

Relaxed Analog Input Timing Enable

Interleaved Multicast Streams Enable

Low Power Mode Enable

RS232 Settings

Effects Settings

Allow SVSi Multicast P0 P1

Disable P1 Disable

FIG. 20 Advanced Settings

TABLE 2 Settings Page: Advanced Settings

Option	Description	Notes
Input Level Gain Left/Right	Select a PRE-ENCODE cut in the audio signal.	This can help prevent distortion of the audio when the source is providing audio that is too loud/clipping. Setting does <i>not</i> affect digital audio.
Audio Gain	Slide right to provide a POST-ENCODE boost in the audio signal (to both left and right channels).	This can help compensate when the source is providing a weak audio signal. Does not affect digital audio.
Audio Gain Left/Right	Slide right to provide a POST-ENCODE boost in the left or right channel's audio signal.	This can help compensate when the source is providing a weak audio signal. Does not affect digital audio.
Microphone bias	Use to set the voltage bias of the microphone.	Different audio inputs require a different bias. Setting choices are 2V , 2.5V , 3.3V , and Off . The default is Off .
Audio Encrypt	Enable to encrypt the audio stream.	Encryption is on by default. Turn off encryption to allow for compatibility with other devices that require a decrypted stream.
Brightness	Use sliders to raise or lower RGB values of the Encoder (POST-ENCODE).	Only affects analog video. Does not affect digital video.
Horz Offset	Enter the number of pixels to shift the screen to the left. Range is -4 to 4 pixels.	The higher the number, the more to the left the screen will shift. <i>Enter even numbers only</i> to prevent red/blue color swapping.
Vert Offset	Enter the number of pixels to shift the screen up and down. Range is -100 to 100 pixels.	The higher the number, the higher the screen will shift.
Component Sync Window	Use this slider to configure the sync on green sensitivity.	Used for computer video input to help with screen flickering.
Input audio for HostPlay	Enable to activate the input audio when the Live/Local menu is set to one of the local images.	
HostPlay for Unsupported	Enable to cause the Encoder to go into HostPlay mode whenever the source provides unsupported video.	
Gratuitous ARP	Enable the Encoder to send a periodic Address Resolution Protocol (ARP) packet to the network.	
ARP Interval (secs)	Determine how often (in seconds) the unit transmits gratuitous ARP packets.	
Unsolicited Status	Enable the Encoder to send a periodic status packet to the Send Status Address described below.	
Send Status Address	When Unsolicited Status is enabled, the Encoder sends a periodic status packet to the IP address specified here.	
Status Interval (secs)	Determine how often (in seconds) the unit transmits status packets.	
Discovery Packet Transmit	Enable the N-Series multicast discovery service (which is used to identify units).	This is useful for larger network integrations when broadcast packets will not cover the entire network. Enabled by default.
Discovery Interval (secs)	Determine how often (in seconds) the unit transmits discovery packets.	
TTL	Select the Time To Live (TTL) for the transmit audio and video streams.	Limits the lifespan of data on the transmit audio and video streams (to improve performance).
Video VLAN Tagging	When enabled, tags the video and audio IP packet with the VLAN number.	
Video VLAN #	Enter the VLAN number.	This number will be included in the video and audio IP packet when VLAN Tagging is enabled.
DSCP #	Select the Differentiated Services Code Point (DSCP) for the transmit audio and video streams.	
Serial Master Enable	Enable this device to be the master to the designated slave.	Once set in master mode, outside serial commands will be ignored.
Serial Slave Address	Enter the IP address of the serial slave device.	
IR Command Holdoff	Set the delay between IR command portions. The default setting is 25 ms.	IR commands are sent in two parts. This setting is the time (in milliseconds) between transmission of part one and part two. The second part of the command is inverted for confirmation purposes.

TABLE 2 Settings Page: Advanced Settings (Cont.)

Option	Description	Notes
IR Repeat Holdoff	Set the repeat delay between IR commands. The default setting is 90 ms.	This is the amount of time before a new command is sent. For example, when pressing and holding the volume button on a remote control, this is how long until the command is repeated.
Relaxed Analog Input Timing	Enable to allow small variances in the analog input (to avoid video interruption).	
Interleaved Multicast Streams	Enables a multicast format which interleaves video and audio streams.	In order for N-Series devices to communicate with each other, their multicast settings must be compatible.
Low Power Mode	Enable to enable low power mode and disable all video and audio.	When enabled, the unit draws less power and produces less heat. It also comes back up much quicker than a full power down. Must be disabled for the unit to work again.

RS232 Settings

The section of the **Settings** page shown in [Figure 21](#) is displayed when you click the **RS232 Settings** link. Options are described in [Table 3](#).

The screenshot shows the 'RS232 Settings' section with the following values:

- RS232 Baud Rate: 9600
- RS232 Data Bits: 8
- RS232 Parity: none
- RS232 Stop Bits: 1

FIG. 21 RS232 Settings**TABLE 3** Settings Page: RS232 Settings

Option	Description
RS232 Baud Rate	Select the appropriate baud rate for the RS232 serial interface. Default is 9600.
RS232 Data Bits	Select the appropriate data bit count for the RS232 serial interface. Default is 8.
RS232 Parity	Select the appropriate parity for the RS232 serial interface. Default is no parity (none).
RS232 Stop Bits	Select the appropriate number of stop bits for the RS232 serial interface. Default is 1.

Effects Settings

The section of the **Settings** page shown in [Figure 22](#) is displayed when you click the **Effects Settings** link. Options are described in [Table 4](#).

The screenshot shows the 'Effects Settings' section with the following values:

- Border Enable: Enable
- Border Size: 16
- Border Color: #ff006f

FIG. 22 Effects Settings**TABLE 4** Settings Page: Effects Settings

Option	Description
Border Enable	Enable to add a border around the video. This can help identify the video associated with a specific device.
Border Size	Adjust the border size (in pixels).
Border Color	Set a color for the border.

Network Setup Section

The **Network Setup** section of the **Settings** page is shown in [Figure 23](#). Options are described in [Table 5](#).

Network Setup

IP Mode: AUTO IP

IP address: 169.254.82.25

Netmask: 255.255.0.0

Gateway address: 169.254.1.1

Ping Test: [Ping](#)

FIG. 23 Network Setup Section

TABLE 5 Settings Page: Network Setup Settings

Option	Description	Notes
IP Mode	Configure the IP address mode. When set to AUTO IP , an IP Address in the range of 169.254.xxx.xxx with Netmask of 255.255.0.0 and Gateway address of 169.254.1.1 will be automatically assigned to the N2400 Encoder by the control software. When set to DHCP , an IP Address in the range of the DHCP server on the network will be automatically assigned to the N2400 Encoder. When set to STATIC , an IP address , Netmask , and Gateway address must be manually entered.	DHCP is the default setting. However, using DHCP beyond initial setup is generally not recommended. If the device is set to DHCP and fails to receive an address from the DHCP server in time, it will revert back to the AUTO IP address (169.254.xxx.xxx) until the unit is rebooted.
IP address	View the current IP address of the N2400 Encoder. When in STATIC mode, enter a new IP address into this field.	
Netmask	View the current Netmask of the N2400 Encoder. When in STATIC mode, enter a new Netmask into this field.	
Gateway address	View the current Gateway address of the N2400 Encoder. When in STATIC mode, enter a new Gateway address into this field.	
Ping Test	Test the connection by specifying an IP address or URL to ping. Click the Ping link to initiate the test.	
Trial Save	Click to initially save IP address changes. Once you log in to the unit using the new address, you will be able to confirm and accept the changes permanently.	

Status Section

The **Status** section of the **Settings** page is shown in [Figure 24](#). Options are described in [Table 6](#).

Status

HDMI Status: connected

Source Resolution: 1920x1080 (60.00 Hz)

HDMI Status Pass Thru: connected

Current Bandwidth: 2.1 Mbps

Port 50001 Source IP: Disconnected

Port 50002 Source IP: Disconnected

Serial Source IP: Disconnected

KVM IP: Inactive

Port P0: Disconnected

Port P1: Disconnected

FIG. 24 Status Section

TABLE 6 Settings Page: Status Section

Option	Description	Notes
HDMI Status	Indicates if data is being sent to the HDMI port.	
Source Resolution	Indicates the video resolution of the currently connected source.	
HDMI Status Pass Thru	Indicates if a display device is connected to the Encoder.	
Current Bandwidth	This is a snapshot of the unit as properties were loaded to the browser, not a live counter. Refresh the page to get an updated bandwidth.	
Port 50001 Source IP	Shows the IP address of the currently connected device or displays Disconnected if no connection exists.	Port 50001 can only accept a single external connection at a time. If a device is currently showing the port occupied (by a control system or other device), then other connections will be rejected. However, connection attempts from the same IP will override the current connection.
Port 50002 Source IP	Shows the IP address of the currently connected device or displays Disconnected if no connection exists.	Port 50002 can only accept a single external connection at a time. If a device is currently showing the port occupied (by a control system or other device), then other connections will be rejected. However, connection attempts from the same IP will override the current connection.
Serial Source IP	Shows the IP address of the currently connected device or displays Disconnected if no connection exists.	Only a single external connection can be accepted on the port. If a device is currently showing the port occupied (by a control system or other device), then other connections will be rejected. However, connection attempts from the same IP will override the current connection.
Flush buttons	These buttons reset the port.	
KVM IP	If a KVM Decoder is currently connected to this Encoder, its IP address displays here.	
Port P0	Shows the IP address of the currently connected device or displays Disconnected if no connection exists.	
Port P1	Shows the IP address of the currently connected device or displays Disconnected if no connection exists.	

Change Password Section

To change the N2412A Encoder interface password, enter the current password in the field labeled **Old Password**, and enter a new password in the **New Password** and **Confirm Password** fields. Click **Change PW** to accept the new password.

FIG. 25 Change Password

NOTE: This password needs to match N-Able's stored password to allow auto-login using N-Able.

LDAP Section

The section of the **Settings** page shown in [Figure 26](#) is displayed when you click the **Configure LDAP** link. Options are described in [Table 7](#).

FIG. 26 LDAP Section

TABLE 7 Settings Page: LDAP Section

Option	Description
Enable LDAP	Enable to configure the unit to access the network's LDAP (lightweight directory access protocol) services.
Server Domain	Enter the IP address of the LDAP server.
AD Name	Enter the Active Directory's name.
Save LDAP	Click to save setting made to this section.

Software Section

The **Software** section of the **Settings** page is shown in [Figure 27](#). Options are described in [Table 8](#).

FIG. 27 Software Section

TABLE 8 Settings Page: Software Section

Option	Description
Model	Displays the model number of the N2400 Encoder.
Serial	Displays the serial number of the N2400 Encoder.
MAC Address	Displays the MAC address of the network interface of the N2400 Encoder.
Firmware Version	Displays the date code for the currently running version of the N2400 Encoder internal firmware.
Web Version	Displays the date code for the currently running version of the web interface.
Factory Restore	Click to restore the device to the original factory settings. This resets everything except the IP address (including name, stream number, serial settings, etc.).
Reboot	Click to begin a software reboot. This command does not initiate a full power cycle and does not affect the current configuration.

HDMI Pass Thru Settings

The section of the **Settings** page show in [Figure 28](#) is displayed when you click the **HDMI Pass Thru Settings** link. Options are described in [Table 9](#).

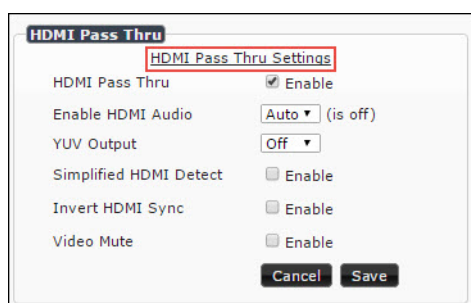
**FIG. 28** HDMI Pass Thru Settings**TABLE 9** Settings Page: HDMI Pass Thru Settings

Option	Description
HDMI Pass Thru	Enables looped output.
Enable HDMI Audio	Determines if the unit will output audio over the HDMI connection. Selecting Auto bases audio output on the settings of the connected source device.
YUV Output	For color conversion. Can force to RGB output based on connected device's reported settings. Default (and preferred setting) is Off .
Simplified HDMI Detect	When enabled, detects HDMI solely based on the hot plug detection. Enable to help prevent displays/monitors from going to sleep.
Invert HDMI Sync	Inverts horizontal and vertical synchronization to the output display. Used for non-standard displays.
Video Mute	When enabled, the output video stream is forced to black screen.
Cancel	Click to return all controls to the last saved configuration.
Save	Click to accept changes made to these controls.

HostPlay Page

Click the **HostPlay** link at the top of any of the main web pages to access the page shown in [Figure 29](#). This page allows you to upload new images to the Encoders and configure the image playlists. The playlist will be shown on the display when no video is being transmitted or received. You can show a single image or set up multiple images to be displayed at a customized animation rate. Audio can be uploaded and set to play whenever HostPlay is active. See [Table 10](#) for option descriptions.

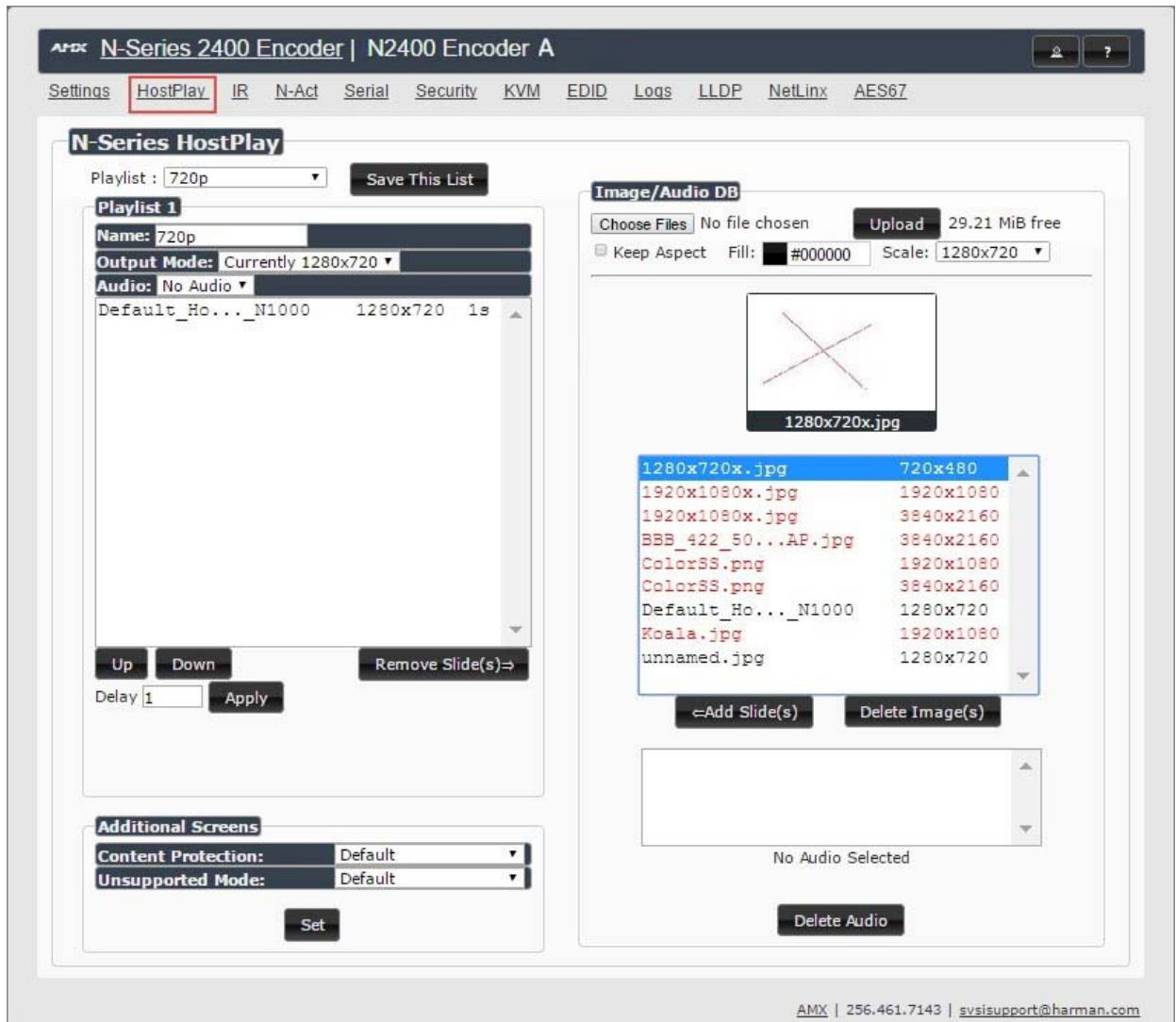

FIG. 29 HostPlay Page

TABLE 10 HostPlay Page Options

Option	Description
Playlist	Select a playlist from the drop-down menu to view/edit the images currently used in the chosen image playlists. If more than one image appears in the list, a transition time can be set for each image.
Save This List	Click to save the current configuration.
Name	View/Edit the name for the playlist.
Output Mode	Select the HostPlay output resolution. The playlists that were uploaded in that resolution are then displayed for your selection. The Output Mode for the playlist and the loaded image (Scale setting when loaded) need to match.
Audio	Choose an audio file to play while the HostPlay image is on the screen.
Up/Down buttons	Use to adjust the order of images in the current list.
Remove Slide(s) button	Click to remove the selected slide from the playlist.
Delay	Set a delay (in seconds) between slides in the playlist being displayed.
Image/Audio DB list	This section provides the ability to upload image and audio files to the N2412 Encoder database.
Keep Aspect checkbox	Enable to lock in the aspect ratio of the given image when displaying.

TABLE 10 HostPlay Page Options (Cont.)

Option	Description
Fill	Customize the background color (used behind HostPlay images that do not take up the entire screen).
Scale	Choose an aspect ratio for display. The Output Mode for the playlist and the loaded image (Scale setting when loaded) need to match.
Add Slide(s) button	Click to add the selected slide to the current playlist (shown on the left side of the screen).
Delete Image(s) button	Delete the selected image file from the playlist.
Additional Screens	Allows you to choose what is displayed as the HostPlay page if there is an unsupported mode or content protection issue.
Delete Audio	Delete the selected audio file from the playlist.

IR Page

Click the **IR** link at the top of any of the main web pages to access the page shown in [Figure 30](#). This page allows you to upload and execute IR Pronto codes so that other vendor's devices can be controlled through the Encoder's IR connector. Commands can be saved for future use and executed later. The **IR Code** menu lists all saved IR commands. See [Table 11](#) for option descriptions.

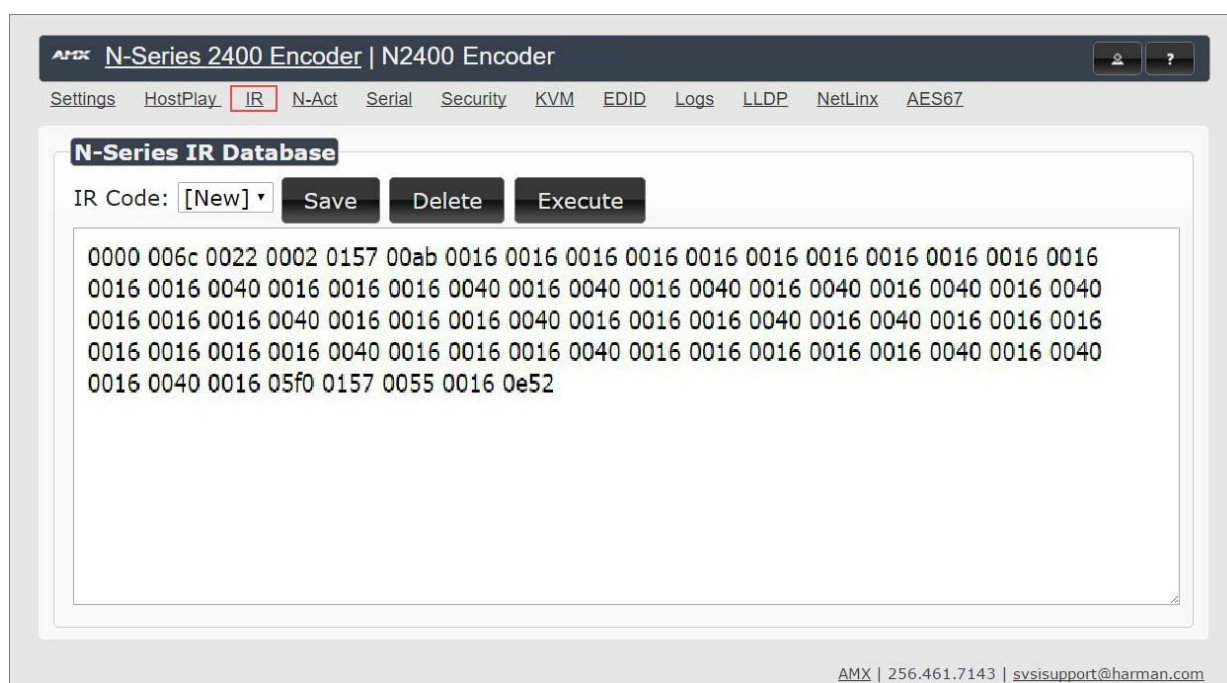
**FIG. 30** IR Page**TABLE 11** IR Page Options

Option	Description
IR Code	Create/select IR codes. Different vendors have different IR Pronto codes that can usually be found through a web search. Copy/paste new IR commands directly into the input space. To create a new code, select [New] from this drop-down, replace the content in the white box, enter a name, and click the Save button.
Save	Save the current code.
Delete	Delete the current code.
Execute	Activate the selected code through the Encoder's IR connector.

N-Act Page

Click the **N-Act** link at the top of any of the main web pages to access the page shown in [Figure 31](#). This page allows you to create command lists which are performed automatically by the unit based on power or video connection (without the use of an outside controller). For example, you can tell a projector and lights to come on when the Encoder powers up. You can add multiple commands for each event. See [Table 12](#) for option descriptions.

N-Act Events

- N-Act Events must first be enabled. See check box below.
- SVSi N-Series use TCP ASCII or UDP ASCII port 50002 for control.
- Conductor N8000s accept script commands on TCP ASCII port 50020.
- All control commands are terminated by a carriage return \r.
- SVSi N-Series use TCP HEX port 50004 for serial.
- The SVSi N-Series Serial page has an ASCII/HEX Converter.
- Trigger Delay can be 0 to 86400 seconds (24 hours).
- After the Trigger Delay, each command is executed in order with a Delay (ms) between each command.
- Macros are supported in ASCII mode with the {{Name}} notation (case-sensitive). Upon executing, Current value will be substituted.
- Encoder Hostplay does not trigger connect/disconnect events unless in live mode.

Enable N-Act Events Events must be enabled for N-Act to work

Power On Event Test

Protocol: TCP ASCII Address: 127.0.0.1 Port: 50001 Data: Data Delay (ms): 1 Delete

Video Cable Connected Event Trigger Delay: 1 Test

Protocol: TCP ASCII Address: 127.0.0.1 Port: 50001 Data: Data Delay (ms): 1 Delete

Video Cable Disconnected Event Trigger Delay: 1 Test

Protocol: TCP ASCII Address: 127.0.0.1 Port: 50001 Data: Data Delay (ms): 1 Delete

Generic Events AudioChannelCount Add Generic Event

Save Events

Import/Export

Import Choose File No file chosen **Import N-Act**

Export Export Saved N-Act

AMX | 256.461.7143 | svsisupport@harman.com

FIG. 31 N-Act Page

TABLE 12 N-Act Page Options

Option	Description
Enable N-Act Events	Enable to activate the configured events.
Power on Event	Create/delete/test events to be performed when the Encoder powers on. Visit our website for more details on Application Programming Interface (API) commands.
Video Cable Connected Event	Create/delete/test events to be performed when the Encoder is connected to a video source. The Trigger Delay field specifies how long the device has to be connected for the command to be executed.
Video Cable Disconnected Event	Create/delete/test events to be performed when the Encoder is disconnected from a video source. The Trigger Delay field specifies how long the device has to be disconnected for the command to be executed. This keeps accidental (momentary) disconnects from triggering the command sequence.
Generic Events	Create custom N-Act events. These can be based on most web page or status changes for the unit. NOTE: An Address of 127.0.0.1 basically means to perform the event to THIS unit (on which the N-Act event is being configured).
Save Events	Click to save changes made to this page.
Import/Export	Use this section of the page to import/export N-Act event configurations. from one N-Series unit to other N-Series units.

Serial Page

Click the **Serial** link at the top of any of the main web pages to access the page shown in [Figure 32](#). This page allows you to upload and execute commands used for direct control of serial devices. Commands may be saved for future use and executed later. The **Serial Code** menu lists all saved commands. See [Table 13](#) for option descriptions.

NOTE: *If the Port 5004/Serrial Port is currently in use by another device, sending commands from the Serial page will always return a No Data message and fail to send the commands.*

FIG. 32 Serial Page

TABLE 13 Serial Page Options

Option	Description
Serial Code	Create/select serial commands. Different vendors have different codes that can usually be found through a web search. Copy/paste new commands (in either ASCII or HEX) directly into the appropriate input space. To create a new code, select [New] from this drop-down, replace the content in the white box, enter a name, and click the Save button.
Save	Save the current code.
Delete	Delete the current code.
Execute	Apply the selected code to the Encoder's serial connection.
ASCII and HEX	Paste serial commands directly into either the ASCII or HEX field.
Response	View responses provided by the device receiving the serial command(s).

Security Page

Click the **Security** link at the top of any of the main web pages to access the page shown in [Figure 33](#). This page allows you to customize the security settings on your unit. See [Table 14](#) for option descriptions.

FIG. 33 Security Page

TABLE 14 Security Page Options

Option	Description
General Security	
Force HTTPS Connection	Enable to force web page accesses to always be HTTPS.
Change Stream Encryption Password	Set the default password for stream encryption. To successfully communicate, the Decoder and Encoder passwords must match. Click Reset to return to default password and settings.
Command Port Security	
Secure Ports Only	If enabled, commands must be sent using secure sockets (TLS/SSL) and follow the secure command port protocol.
Change Command Password	Set the default password for command encryption. When issuing API commands, this password must precede each command in the format: <password>\r<command>.
802.1X Port Security	
Enable checkbox	Click to turn on 802.1X security.
Status	Displays status of the current port connection as either Disabled , Authorized , or Unauthorized .
Configuration	Select Simple or Custom . Use Simple for configurations that require only a user name and password. Use Custom for more advanced configurations.

TABLE 14 Security Page Options

Option	Description
Change 802.1x User Name/Password	Enter a new user name and password to use for 802.1x security. They are used when negotiating a secure port with the network. These settings are available only when Configuration is set to Simple .
Custom Config File	Upload a custom wpa_supplicant.conf file. See your network administrator for details. This option is available only when Configuration is set to Custom .

KVM Page

Click the **KVM** link at the top of any of the main web pages to access the N-Series **KVM** page. You must check the **USB Enable** box at the top to see the page shown in [Figure 34](#). See [Table 15](#) for option descriptions.

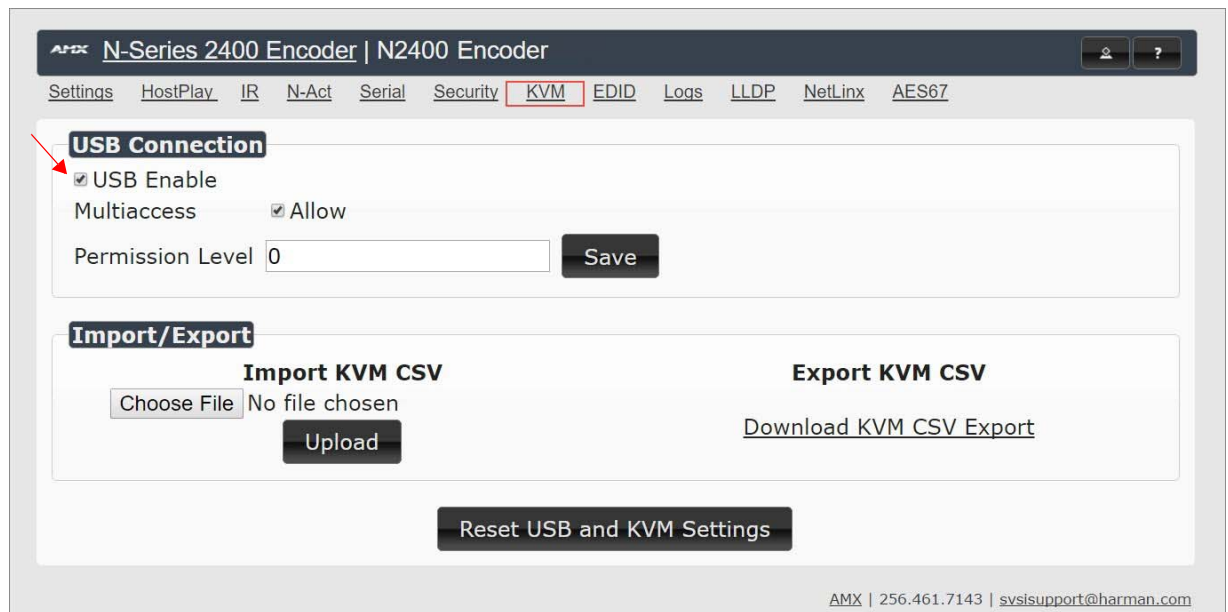

FIG. 34 KVM Page

TABLE 15 KVM Page Options

Option	Description
USB Enable	Enable to allow the ability to share mouse and keyboard over the network. Enabled by default. When disabled, the unit works like a non-KVM unit and ignores any keyboard or mouse activity.
Multiaccess	Enable to allow multiple Decoders to access this Encoder at the same time. (maximum is 100 connections).
Permission Level	Set the permission level for the Encoder. Decoders can only establish USB connection to Encoders with the same or higher permission level.
Import KVM CSV	Click the Choose File button and browse to the KVM CSV file on your computer that you would like to use to configure the unit. Then click Upload .
Export KVM CSV	Click the Download KVM CSV Export link to retrieve the current KVM CSV configuration file.
Reset USB and KVM Settings	Resets all USB and KVM settings.

EDID Page

Click the **EDID** link at the top of any of the main web pages to access the page shown in [Figure 35](#). Every display has stored information that it communicates to the output device. This page allows you to view that information. Options are described in [Table 16](#). Edit the Encoder's EDID if you need to change the display options available to the source. There are four different ways to control the EDID of the Encoders.

Option 1: Use the default settings drop-down menu and select from the options available. Then click **Set EDID**. This will work for most sources and is most often set to **Stereo (2 channel)**.

Option 2: When using an EDID captured from a display connected to a Decoder, paste the data in to the white EDID block, overwriting existing EDID. Then click **Set EDID**.

Option 3: Make changes to the operating parameters displayed on the right side of the screen. Use the **Encode** button to translate the changes into a new EDID and click **Set EDID**.

Option 4: Connect a compatible display to the Encoder's **HDMI Out** port and click **Set EDID to Pass-thru**.

NOTE: The source will need to be disconnected while modifying EDID settings.

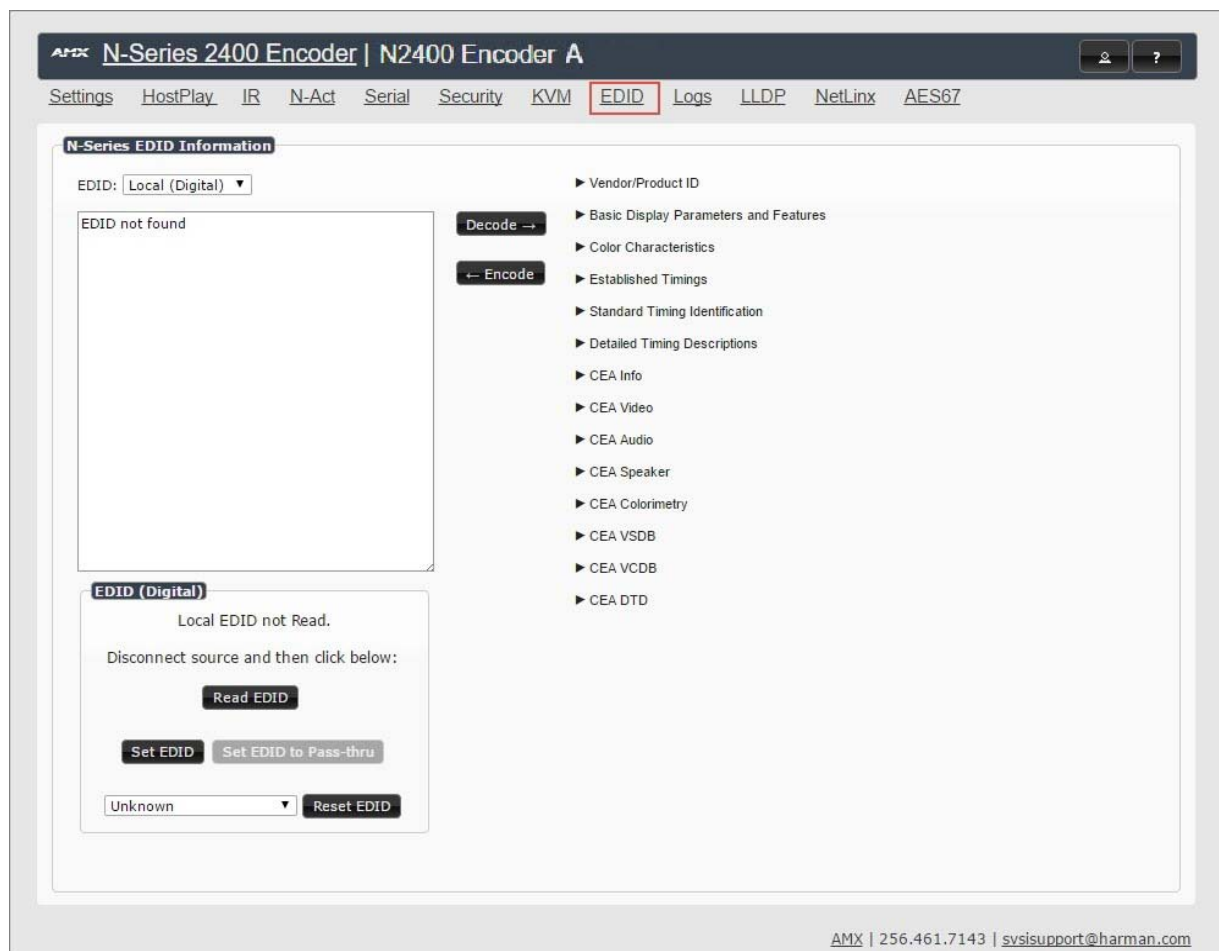

FIG. 35 EDID Page

TABLE 16 EDID Page Options

Option	Description
EDID drop-down box	Select what EDID information to display. Pass-thru: Displays EDID information for the display connected to the Encoder's pass thru port. Local (Digital/Analog): Displays EDID information for the Encoder. This information is being provided to the source connected to the Encoder.
Decode button	Click to translate the EDID currently displayed on the left to the operating parameters list on the right.
Encode button	After making any changes to the operating parameters list on the right, click this button to update the EDID information on the left. To store the new settings, click Set EDID .
Read EDID	Click to initially show the EDID or if the source EDID has changed (refreshes the EDID table).
Set EDID	If creating a custom EDID, click to apply the changes.

TABLE 16 EDID Page Options (Cont.)

Option	Description
Set EDID to Pass-thru	Set the EDID to the pass-thru EDID of the connected display to HDMI OUT .
Reset EDID	For Digital , choose a standard EDID from the drop-down menu and click Reset EDID to apply. For Analog , no selection is necessary.

Logs Page

Click the **Logs** link at the top of any of the main web pages to access the page shown in [Figure 36](#). The **Logs** page displays a command log that lists all TCP and UDP messages the unit receives. It also displays the web browser's IP address and gives you options to **Refresh** and **Reset Logs**. When in need of assistance from tech support, you can use the Debug Log section to capture useful troubleshooting information. Simply click the Start Debug Log button, wait at least one minute, and click the End Debug Log button to create the file. You can then download and send it to AMX tech support.

The screenshot shows the AMX N-Series 2400 Encoder web interface. The top navigation bar includes links for Settings, HostPlay, IR, N-Act, Serial, Security, KVM, EDID, **Logs**, LLDP, NetLinx, and AES67. Below the navigation bar, the user's IP address is displayed as 169.254.55.86. There are buttons for Refresh Logs and Reset Logs. The main content area is titled "Command Log" and contains a table with the following data:

Elapsed Time	IP	Port	Method	Command
2 days, 19 hrs, 2 min, 54 sec	Web page	50003	TCP	vunmute\r
2 days, 19 hrs, 2 min, 58 sec	Web page	50003	TCP	vmute\r
2 days, 19 hrs, 3 min, 7 sec	Web page	50003	TCP	setSettings:borderEnable:off\r
2 days, 19 hrs, 3 min, 12 sec	Web page	50003	TCP	setSettings:borderEnable:on\rsetSettings:borderColor:#ff006f\r
2 days, 19 hrs, 3 min, 19 sec	Web page	50003	TCP	setSettings:borderEnable:off\r
2 days, 19 hrs, 3 min, 22 sec	Web page	50003	TCP	setSettings:borderEnable:on\r
2 days, 19 hrs, 3 min, 26 sec	Web page	50003	TCP	setSettings:borderEnable:off\rsetSettings:borderSize:16\r
2 days, 19 hrs, 3 min, 37 sec	Web page	50003	TCP	vunmute\r

FIG. 36 Logs Page

NOTE: For security reasons, only use the Enable Maintenance Mode if instructed by AMX Technical Support. This selection only appears in the secure version of the website (i.e., https).

LLDP Page

Click the **LLDP** link at the top of any of the main web pages to access the page shown in [Figure 37](#). The **LLDP** page displays information from the Link Layer Discover Protocol (LLDP) packet which identifies the port number and switch the device is connected to.

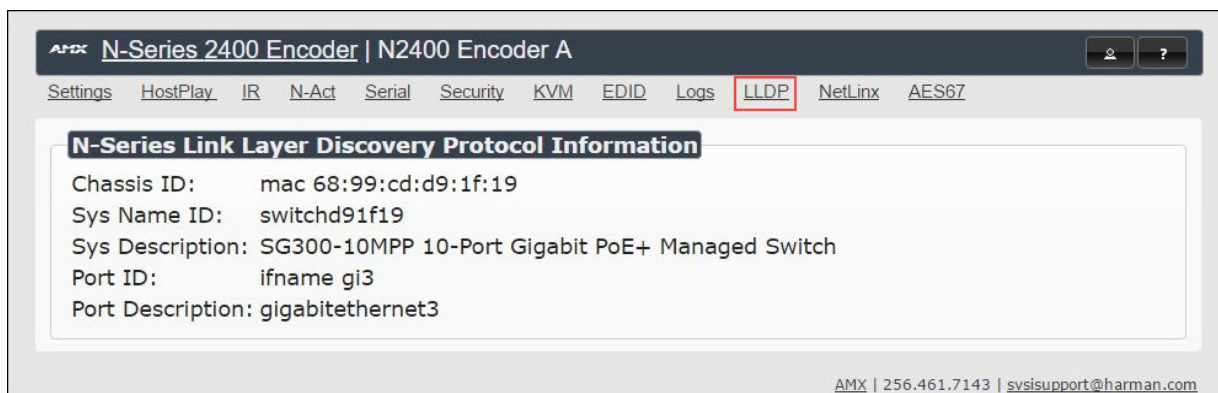

FIG. 37 LLDP Page

NetLinx Page

Click the **Netlink** link at the top of any of the main web pages to access the page shown in [Figure 38](#). Options are described in [Table 17](#). This page allows you to prepare your N2400 for NetLinx-driven configuration. This is explained in more detail in [Appendix A: NetLinx Control](#) on page 71.

NOTE: *NetLinx takes over the Serial port when active.*

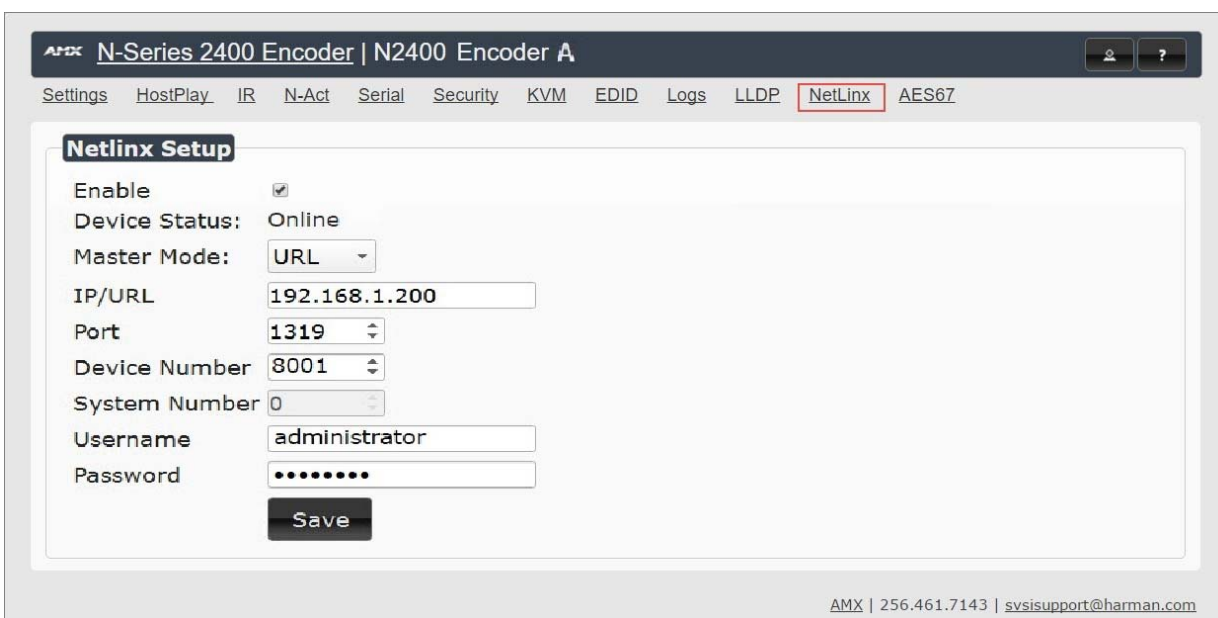

FIG. 38 NetLinx Page

TABLE 17 NetLinx Page Options

Command	Description
Enable	Click to enable/disable NetLinx on this device.
Device Status	This status field will show the device to be Online , Connected , Offline , or Unknown .
Master Mode	Select Auto , Listen , or URL .
IP/URL	Enter the address of the Master Controller.

TABLE 17 NetLinX Page Options (Cont.)

Command	Description
Port	This field should always be set to 1319 .
Device Number	Defaults to a dynamic device number. May be set to a static range (e.g., 8000).
System Number	Determines which system to connect. This setting is dependent upon the Master Mode selected (see above). <ul style="list-style-type: none"> • If Master Mode is set to Auto, the System Number is set and the system discovers the Master Controller's IP address. • If Master Mode is set to Listen, the device connects to any Master Controller. • If Master Mode is set to URL, the IP of the Master Controller is set.
Username	Username for the Master Controller.
Password	Password for the Master Controller.
Save button	Click to save settings made on this page.

AES67 Page

Click the **AES67** link at the top of any of the main web pages to access the page shown in [Figure 39](#). Options are described in [Table 18](#). AES67 is an open standard for audio over IP and audio over Ethernet. This page allows you to configure the Encoder to generate AES67 audio and send it to devices that support it.

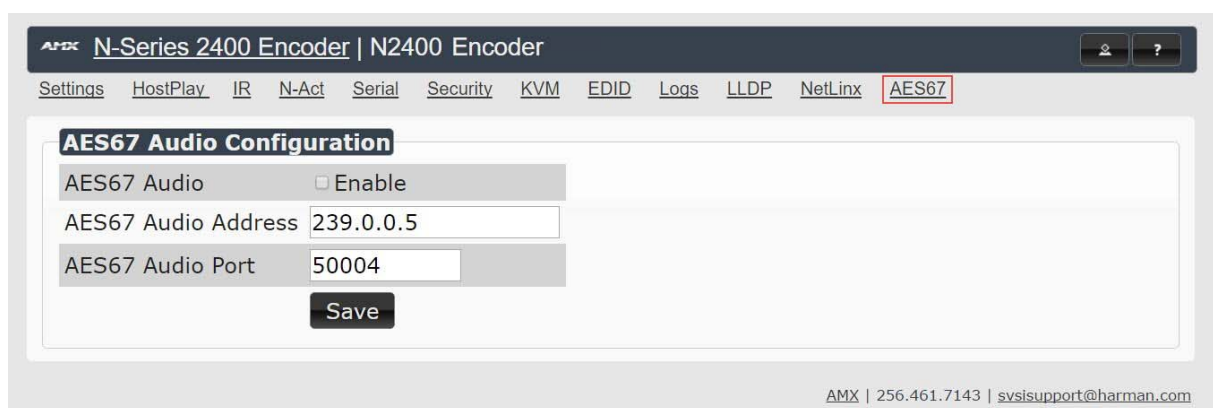
**FIG. 39** AES67 Page**TABLE 18** AES67 Page Options

Command	Description
AES67 Audio	Enable to turn on AES67 audio and turn off other audio streams.
AES67 Audio Address	Enter the IP address of the destination device. The address's first octet must start with 239 (e.g., 239.xxx.xxx.xxx). It will not work with other numbers for the first octet.
AES67 Audio Port	Enter the port number of the destination device.
Save button	Click to save settings made on this page.

Chapter 4: Decoder Configuration Options

This chapter defines N2422A Decoder configuration options. For ease of navigation, it is organized to reflect the graphical user interface (GUI).

As explained previously in the [Encoder Configuration Options section on page 23](#), you can access the GUI main pages by clicking the links in the top navigation bar. [Figure 40](#) shows the navigation bar and provides hot links to the sections of this chapter which describe each main page.

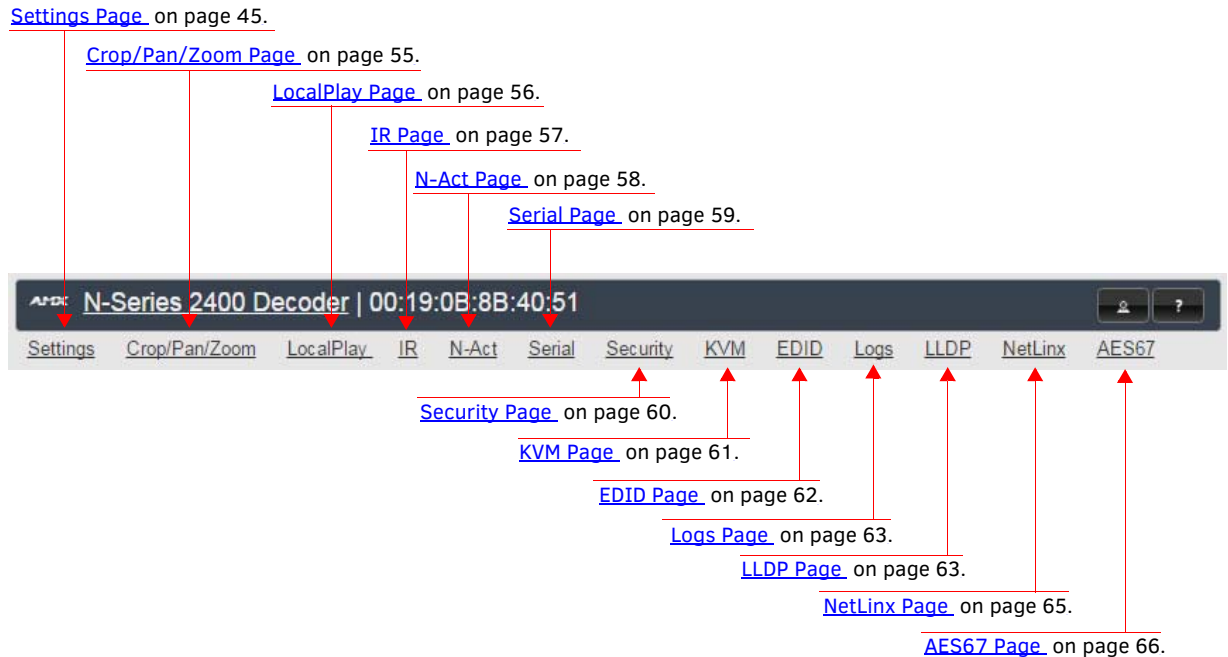

FIG. 40 Section Links

Settings Page

Click the **Settings** link at the top of any of the main web pages to access the page shown in [Figure 41](#). This page is divided into several sections and also has links to other dialog boxes for additional configuration options. Refer to the following sections for detailed descriptions:

- [Decoder Setup Section on page 46](#)
- [Advanced Settings on page 48](#)
- [RS232 Settings on page 50](#)
- [Effects Settings on page 50](#)
- [Network Setup Section on page 51](#)
- [Status Section on page 51](#)
- [Change Password Section on page 53](#)
- [LDAP Section on page 53](#)
- [Software Section on page 53](#)
- [Audio Downmixer Settings on page 54](#)

The screenshot displays the AMX N-Series 2400 Decoder Settings Page. The page title is "N-Series 2400 Decoder | 00:19:0B:8B:40:4A". The navigation menu includes: Settings, Crop/Pan/Zoom, LocalPlay, IR, N-Act, Serial, Security, KVM, EDID, Logs, LLDP, NetLinX, and AES67. The main content area is divided into several sections:

- Decoder Setup:**
 - Device Name: 00:19:0B:8B:40:4A
 - Stream: 2411 (Video: 239.255.9.107:50002)
 - Audio Stream: 0 (Audio: (AES67) 239.255.100.91:50003)
 - Audio Follows Video: Follows
 - Scaler: Enable
 - Output Mode: 720p60
 - Live/Local: Live
 - Video Mute: Mute
 - Audio Mute: Mute
 - Lineout Volume: (Set Left/Right)
 - Enable HDMI Audio: Auto
 - Buttons: Cancel, Save
- Network Setup:**
 - IP Mode: AUTO IP (dropdown: AUTO IP)
 - IP address: 169.254.114.114 (dropdown: 169.254.114.114)
 - Netmask: 255.255.0.0 (dropdown: 255.255.0.0)
 - Gateway address: 169.254.1.1 (dropdown: 169.254.1.1)
 - Ping Test: 169.254.1.1 (dropdown: Ping)
 - Button: Trial Save
- Status:**
 - HDMI Status: connected
 - Source Resolution: 1280x720 (60.00 Hz)
 - Port 50001 Source IP: Disconnected (Button: Flush)
 - Port 50002 Source IP: Disconnected (Button: Flush)
 - Serial Source IP: Disconnected (Button: Flush)
 - KVM IP:
 - Port P0: Disconnected
 - Port P1: Disconnected
- Change Password:**
 - Button: Change Password
- Software:**
 - Model: N2422A
 - Serial: 14920000094
 - MAC address: 00:19:0B:8B:40:35
 - Firmware Version: v0.5.10 (2/21/2017)
 - Web Version: 2/8/2017
 - Buttons: Factory Restore, Reboot
- Audio Downmixer:**
 - Button: Audio Downmixer Settings

At the bottom right, the footer text reads: AMX | 256.461.7143 | svsisupport@harman.com

FIG. 41 Settings Page

Decoder Setup Section

The **Decoder Setup** section of the **Settings** page is shown in [Figure 42](#). Options are described in [Table 19](#).

Decoder Setup

Device Name: 00:19:0B:8B:40:4A

Stream: 2411
Video: 239.255.9.107:50002

Audio Stream: 0
Audio: (AES67) 239.255.100.91:50003

Audio Follows Video Follows

Scaler Enable

Output Mode: 720p60

Live/Local: Live

Video Mute Mute

Audio Mute Mute

Lineout Volume:
[Set Left/Right](#)

Enable HDMI Audio: Auto

Cancel Save

[Advanced Settings](#)

[RS232 Settings](#)

[Effects Settings](#)

Allow SVS Multicast P0 P1

Disable P1 Disable

Cancel Save

FIG. 42 Decoder Setup Section

TABLE 19 Settings Page: Decoder Setup Section

Option	Description	Notes
Device Name	Enter a user-friendly name for the unit.	More descriptive names in this field help you organize and manage the N-Series system efficiently. Names based on the unit's location and function are very useful. Some good examples are Lobby-Left-VGA (for left side of lobby, VGA input) or CR201-HDMI (for Conference Room 201, HDMI input). Keep in mind the matrices are organized alphanumerically.
Stream	View/edit the current transmit stream number.	To better understand this setting, think of Decoders dialing up channels on a cable box, rather than a traditional AV matrix. Each decoder can dial in a different active channel.
Audio Stream	View/edit the current audio receive stream number.	This stream number only applies if Audio Follows Video is disabled (see below).
Audio Follows Video	Enable to force the Audio Stream to the same as the video stream.	Enabled by default. Disable if you want audio to come in on a different stream.
Scaler	Enable to scale outgoing content to a fixed resolution or to use the Crop/Pan/Zoom functions.	
Output Mode	Select the output resolution of the video to be transmitted to the video output device (e.g., LCD). The Scaler check box must be enabled for this to be applicable.	
Live/Local	Select live video or locally stored images for transmission to the video output device (e.g., LCD). When video is not available, it automatically goes into local mode.	When video is not available, the most recently played local playlist is displayed.

TABLE 19 Settings Page: Decoder Setup Section (Cont.)

Option	Description	Notes
Video Mute	Enable to mute video by outputting solid black.	
Audio Mute	Enable to mute output audio	
Lineout Volume	This slider controls the output gain on the analog audio output. By default, it controls both the left and right lineout channels. Click the Set Left/Right link to control channels individually.	
Enable HDMI Audio	Set HDMI audio to be disabled, enabled, or selected automatically based on the source.	ON forces audio on at all times. AUTO reads the EDID of the connected device to determine whether or not to send audio.
Cancel	Click to return all controls to the last saved configuration.	This button affects all Decoder Setup controls that are listed above it.
Save	Click to accept changes made to the controls.	This button affects all Decoder Setup controls that are listed above it.
Advanced Settings	Refer to Advanced Settings on page 48 for details on the options available from this link.	
RS232 Settings	Refer to RS232 Settings on page 50 for details on the options available from this link.	
Effects Settings	Refer to Effects Settings on page 50 for details on the options available from this link.	
Allow SVSI Multicast	Disable this option to prevent the port from outputting multicast video traffic.	Particularly useful if you are connecting a non-SVSI device (i.e., not an N-Series device) to a port for network-based control.
Disable P1	Completely disables the P1 port for all traffic.	Once disabled, anything connected to the P1 port will no longer be available on the network.
Cancel	Click to return the related controls to the last saved configuration.	This button affects the Allow SVSI Multicast and Disable P1 controls.
Save	Click to accept changes made to the related controls.	This button affects the Allow SVSI Multicast and Disable P1 controls.

Advanced Settings

The section of the **Settings** page shown in [Figure 43](#) is displayed when you click the **Advanced Settings** link. Options are described in [Table 20](#).

FIG. 43 Advanced Settings

TABLE 20 Settings Page: Advanced Settings

Option	Description	Notes
Input audio for LocalPlay	Select to enable the input audio when the Live/Local menu is set to one of the local images.	
YUV Output	Set YUV output to be disabled, enabled, or selected automatically based on the connected display.	
Simplified HDMI Detect	Select to enable the detection of a display device using a simple line level check.	
Last Frame Hold	Select to cause the Decoder to continue playing the last valid video frame if the network connection is lost.	When enabled, Local Play will not appear.
Local Play Holdoff	Enter a delay time (in seconds) that will be the holdoff period before the unit transitions to local play.	The last frame will hold until the specified amount of time passes. Then the unit transitions to Local Play.
HDMI off on stream loss	Select to disable the video output drive when the video stream is not available.	
HDMI Enable	Select to enable output video.	
Gratuitous ARP	Enable the Decoder to send a periodic Address Resolution Protocol (ARP) packet to the network.	
ARP Interval (secs)	Determine how often (in seconds) the unit transmits gratuitous ARP packets.	

TABLE 20 Settings Page: Advanced Settings (Cont.)

Option	Description	Notes
Unsolicited Status	Enable the Decoder to send a periodic status packet to the Send Status Address described below.	
Send Status Address	When Unsolicited Status is enabled, the Decoder sends a periodic status packet to the IP address specified here.	
Status Interval (secs)	Determine how often (in seconds) the unit transmits status packets.	
Discovery Packet Transmit	Enable the N-Series multicast discovery service (which is used to identify units).	This is useful for larger network integrations when broadcast packets will not cover the entire network. Enabled by default.
Discovery Interval (secs)	Determine how often (in seconds) the unit transmits discovery packets.	
Serial Master Enable	Enable this device to be the master to the designated slave.	Once set in master mode, outside serial commands will be ignored.
Serial Slave Address	Enter the IP address of the serial slave device.	
IR Command Holdoff	Set the delay between IR command portions. The default setting is 25 ms.	IR commands are sent in two parts. This setting is the time (in milliseconds) between transmission of part one and part two. The second part of the command is inverted for confirmation purposes.
IR Repeat Holdoff	Set the repeat delay between IR commands. The default setting is 90 ms.	This is the amount of time before a new command is sent. For example, when pressing and holding the volume button on a remote control, this is how long until the command is repeated.
IGMP Joins on Stream Loss	Enable to send Internet Group Management Protocol (IGMP) join messages when no incoming stream is detected.	
IGMP Join Interval	Delay in seconds between sending IGMP join messages (if IGMP Joins on Stream Loss is enabled).	
Auto Sync Control	Enable synchronization of vertical sync with the network.	Enable this option when using multiple Decoders (e.g. when building a video wall) that must be synchronized together.
Auto Sync Rate	Set the rate at which the vertical sync adjusts.	Auto sync works by shifting the output clock time as fast as possible. If the clock rate is pulled too fast, some monitors flicker and have problems.
Auto Sync Max Pull	Set the limit the auto sync can pull the frame rate (in thousandths of a percent).	For example, with a value of 1100, a 60 Hz input can be pulled to produce an output rate of between 59.934 Hz and 60.066 Hz.
Maintain Aspect Ratio	When scalers are enabled, enabling this check box maintains the source's aspect ratio.	
Interleaved Multicast Streams	Enables a multicast format which interleaves video and audio streams.	In order for N-Series devices to communicate with each other, their multicast settings must be compatible.
Low Power Mode	Enable to enable low power mode and disable all video and audio.	When enabled, the unit draws less power and produces less heat. It also comes back up much quicker than a full power down. Must be disabled for the unit to work again.

RS232 Settings

The section of the **Settings** page shown in [Figure 44](#) is displayed when you click the **RS232 Settings** link. Options are described in [Table 21](#).

FIG. 44 RS232 Settings

TABLE 21 Settings Page: RS232 Settings

Option	Description
RS232 Baud Rate	Select the appropriate baud rate for the RS232 serial interface. Default is 9600.
RS232 Data Bits	Select the appropriate data bit count for the RS232 serial interface. Default is 8.
RS232 Parity	Select the appropriate parity for the RS232 serial interface. Default is no parity (none).
RS232 Stop Bits	Select the appropriate number of stop bits for the RS232 serial interface. Default is 1.

Effects Settings

The section of the **Settings** page shown in [Figure 45](#) is displayed when you click the **Effects Settings** link. Options are described in [Table 22](#).

FIG. 45 Effects Settings

TABLE 22 Settings Page: Effects Settings

Option	Description
Border Enable	Enable to add a border around the video. This can help identify the video associated with a specific device.
Border Size	Adjust the border size (in pixels).
Border Color	Set a color for the border.

Network Setup Section

The **Network Setup** section of the **Settings** page is shown in [Figure 46](#). Options are described in [Table 23](#).

The screenshot shows the 'Network Setup' section with the following fields and values:

- IP Mode: AUTO IP (dropdown menu)
- IP address: 169.254.128.95
- Netmask: 255.255.0.0
- Gateway address: 169.254.1.1
- Ping Test: 169.254.1.1 (input field) with a 'Ping' button
- 'Trial Save' button at the bottom

FIG. 46 Network Setup Section

TABLE 23 Settings Page: Network Setup Settings

Option	Description	Notes
IP Mode	Configure the IP address mode. When set to AUTO IP , an IP Address in the range of 169.254.xxx.xxx with Netmask of 255.255.0.0 and Gateway address of 169.254.1.1 will be automatically assigned to the N2400 Decoder by the control software. When set to DHCP , an IP Address in the range of the DHCP server on the network will be automatically assigned to the N2400 Decoder. When set to STATIC , an IP address , Netmask , and Gateway address must be manually entered.	DHCP is the default setting. However, using DHCP beyond initial setup is generally not recommended. If the device is set to DHCP and fails to receive an address from the DHCP server in time, it will revert back to the AUTO IP address (169.254.xxx.xxx) until the unit is rebooted.
IP address	View the current IP address of the N2400 Decoder. When in STATIC mode, enter a new IP address into this field.	
Netmask	View the current Netmask of the N2400 Decoder. When in STATIC mode, enter a new Netmask into this field.	
Gateway address	View the current Gateway address of the N2400 Decoder. When in STATIC mode, enter a new Gateway address into this field.	
Ping Test	Test the connection by specifying an IP address or URL to ping. Click the Ping link to initiate the test.	
Trial Save	Click to initially save IP address changes. Once you log in to the unit using the new address, you will be able to confirm and accept the changes permanently.	

Status Section

The **Status** section of the **Settings** page is shown in [Figure 47](#). Options are described in [Table 24](#).

The screenshot shows the 'Status' section with the following information:

- HDMI Status: disconnected
- Source Resolution: 3840x2160 (60.00 Hz)
- Port 50001 Source IP: Disconnected (with 'Flush' button)
- Port 50002 Source IP: Disconnected (with 'Flush' button)
- Serial Source IP: Disconnected (with 'Flush' button)
- KVM IP:
- Port P0: Disconnected
- Port P1: Disconnected

FIG. 47 Status Section

TABLE 24 Settings Page: Status Section

Option	Description	Notes
HDMI Status	Indicates if video is connected to the Decoder.	
Source Resolution	Indicates the video resolution of the incoming video source.	
Port 50001 Source IP	Shows the IP address of the currently connected device or displays Disconnected if no connection exists.	Port 50001 can only accept a single external connection at a time. If a device is currently showing the port occupied (by a control system or other device), then other connections will be rejected. However, connection attempts from the same IP will override the current connection.
Port 50002 Source IP	Shows the IP address of the currently connected device or displays Disconnected if no connection exists.	Port 50002 can only accept a single external connection at a time. If a device is currently showing the port occupied (by a control system or other device), then other connections will be rejected. However, connection attempts from the same IP will override the current connection.
Serial Source IP	Shows the IP address of the currently connected device or displays Disconnected if no connection exists.	Only a single external connection can be accepted on the port. If a device is currently showing the port occupied (by a control system or other device), then other connections will be rejected. However, connection attempts from the same IP will override the current connection.
Flush buttons	These buttons reset the port.	
KVM IP	If a KVM Encoder is currently connected to this Decoder, its IP address displays here.	
Port P0	Shows the IP address of the currently connected device or displays Disconnected if no connection exists.	
Port P1	Shows the IP address of the currently connected device or displays Disconnected if no connection exists.	

Change Password Section

To change the N2422A Decoder interface password, enter the current password in the field labeled **Old Password**, and enter a new password in the **New Password** and **Confirm Password** fields. Click **Change PW** to accept the new password.

FIG. 48 Change Password

NOTE: This password needs to match N-Able's stored password to allow auto-login using N-Able.

LDAP Section

The section of the **Settings** page shown in [Figure 49](#) is displayed when you click the **Configure LDAP** link. Options are described in [Table 25](#).

FIG. 49 LDAP Section

TABLE 25 Settings Page: LDAP Section

Option	Description
Enable LDAP	Enable to configure the unit to access the network's LDAP (lightweight directory access protocol) services.
Server Domain	Enter the IP address of the LDAP server.
AD Name	Enter the Active Directory's name.
Save LDAP	Click to save setting made to this section.

Software Section

The **Software** section of the **Settings** page is shown in [Figure 50](#). Options are described in [Table 26](#).

FIG. 50 Software Section

TABLE 26 Settings Page: Software Section

Option	Description
Model	Displays the model number of the N2400 Decoder.
Serial	Displays the serial number of the N2400 Decoder.
MAC Address	Displays the MAC address of the network interface of the N2400 Decoder.
Firmware Version	Displays the date code for the currently running version of the N2400 Decoder internal firmware.
Web Version	Displays the date code for the currently running version of the web interface.
Factory Restore	Click to restore the device to the original factory settings. This resets everything except the IP address (including name, stream number, serial settings, etc.).
Reboot	Click to begin a software reboot. This command does not initiate a full power cycle and does not affect the current configuration.

Audio Downmixer Settings

The section of the **Settings** page shown in [Figure 51](#) is displayed when you click the **Audio Downmixer Settings** link. Options are described in [Table 28](#).

**FIG. 51** Audio Downmixer Settings**TABLE 28** Settings Page: Audio Downmixer Settings

Option	Description
Enable HDMI Downmix	Set HDMI audio downmixing to be disabled, enabled, or selected automatically when receiving a 7.1 audio source.
Center Gain slider	Set percentage of audio on center channel mixed into left and right output when downmixing.
Front Gain slider	Set percentage of audio on front left and right channels mixed into left and right output (respectively).
Surround Gain slider	Set percentage of audio on surround when downmixing left and right channels mixed into left and right output (respectively).
Line out source	Select a line out source or select Downmix when using the downmixer.
Cancel	Click to return all controls to the last saved configuration.
Save	Click to accept changes made to these controls.
Defaults	Click to return all controls to their default settings.

Crop/Pan/Zoom Page

Click the **Crop/Pan/Zoom** link at the top of any of the main web pages to access the page shown in [Figure 52](#). This page allows you to customize the viewable portion of the input. See [Table 29](#) for option descriptions.

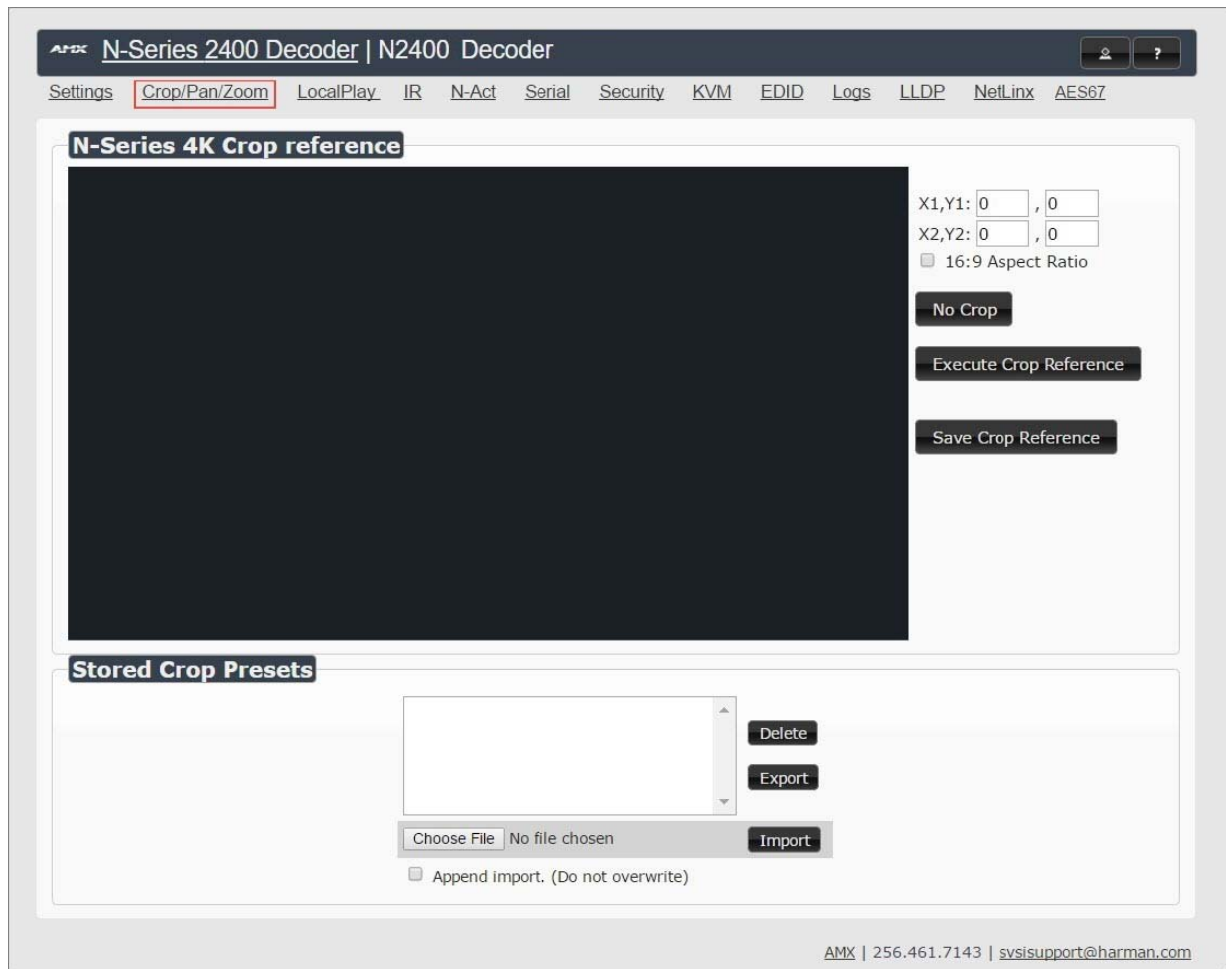

FIG. 52 Crop/Pan/Zoom Page

NOTE: The *Scaler* check box must be enabled for changes on this page to take effect. See the [Settings Page: Decoder Setup Section table](#) on page 46 for more information.

TABLE 29 Crop/Pan/Zoom Page Options

Option	Description
X1, Y1	Set pixel coordinates of viewing area (top left).
X2, Y2	Set pixel coordinates of viewing area (bottom right).
16:9 Aspect Ratio	Enable to force to a 16:9 ratio.
No Crop	Click to disable existing crop settings and return unit to default output settings.
Execute Crop Reference	Click to execute changes.
Save Crop Reference	Click to save the current settings and store them as a preset for later use. Presets can be used by third-party controllers.
Stored Crop Presets	Use this section of the page to select/delete/export/import cropping presets.

LocalPlay Page

Click the **LocalPlay** link at the top of any of the main web pages to access the screen shown in [Figure 53](#). This page allows you to upload new images to the Decoders and configure the image playlists. The playlist will be shown on the display when no video is being transmitted or received. You can show a single image or set up multiple images to be displayed at a customized animation rate. Audio can be uploaded and set to play whenever LocalPlay is active. See [Table 30](#) for option descriptions.

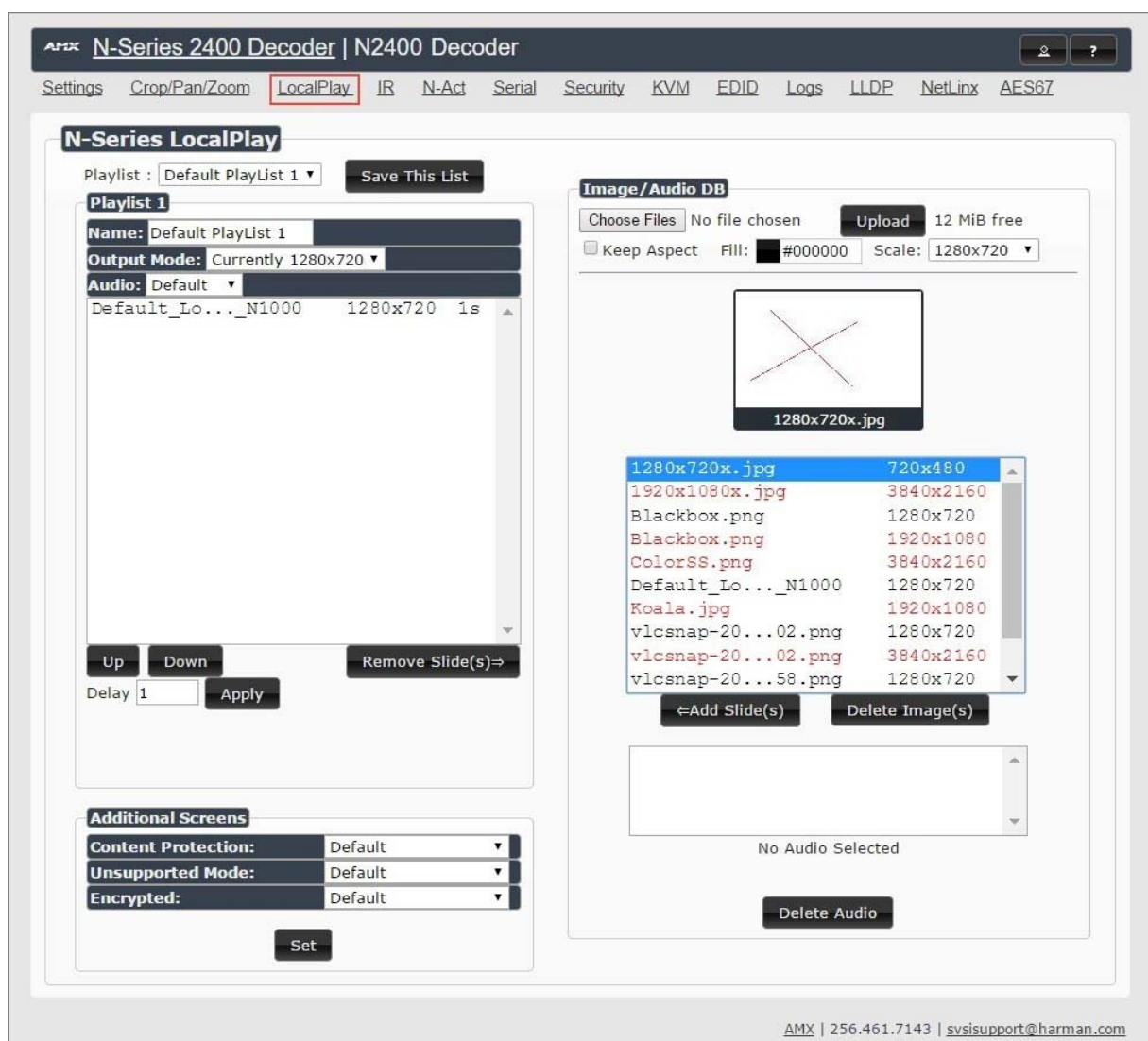

FIG. 53 LocalPlay Page

TABLE 30 LocalPlay Page Options

Option	Description
Playlist	Select a playlist from the drop-down menu to view/edit the images currently used in the chosen image playlists. If more than one image appears in the list, a transition time can be set for each image.
Save This List	Click to save the current configuration.
Name	View/edit playlist names.
Output Mode	Select the resolution you want the image(s) to play in.
Audio	Select an audio file to play while the LocalPlay image is on the screen.
Up/Down buttons	Use to adjust the order of images in the current list.
Remove Slide(s) button	Click to remove the selected slide from the playlist.
Delay	Set a delay (in seconds) between slides in the playlist being displayed.
Additional Screens	Allows you to choose what is displayed as the LocalPlay page if there is a communication or content protection issue. Click the Set button to activate changes.
Image/Audio DB	This section provides the ability to upload image and audio files to the N2422 Decoder database.

TABLE 30 LocalPlay Page Options (Cont.)

Option	Description
Add Slide(s) button	Click to add the selected slide to the current playlist (shown on the left side of the screen).
Delete Image(s)	Delete the selected image file from the playlist.
Delete Audio	Delete the selected audio file from the playlist.

IR Page

Click the **IR** link at the top of any of the main web pages to access the page shown in [Figure 54](#). This page allows you to upload and execute IR Pronto codes so that other vendor's devices can be controlled through the Decoder's IR connector. Commands can be saved for future use and executed later. The **IR Code** menu lists all saved IR commands. See [Table 31](#) for option descriptions.

**FIG. 54** IR Page**TABLE 31** IR Page Options

Option	Description
IR Code	Create/select IR codes. Different vendors have different IR Pronto codes that can usually be found through a web search. Copy/paste new IR commands directly into the input space. To create a new code, select [New] from this drop-down, replace the content in the white box, enter a name, and click the Save button.
Save	Save the current code.
Delete	Delete the current code.
Execute	Activate the selected code through the Decoder's IR connector.

N-Act Page

Click the **N-Act** link at the top of any of the main web pages to access the page shown in [Figure 55](#). This page allows you to create command lists which are performed automatically by the unit based on power or video connection (without the use of an outside controller). For example, you can tell a projector and lights to come on when the Decoder powers up. You can add multiple commands for each event. See [Table 32](#) for option descriptions.

N-Act Events

- N-Act Events must first be enabled. See check box below.
- SVSi N-Series use TCP ASCII or UDP ASCII port 50002 for control.
- Conductor N8000s accept script commands on TCP ASCII port 50020.
- All control commands are terminated by a carriage return \r.
- SVSi N-Series use TCP HEX port 50004 for serial.
- The SVSi N-Series Serial page has an ASCII/HEX Converter.
- Trigger Delay can be 0 to 86400 seconds (24 hours).
- After the Trigger Delay, each command is executed in order with a Delay (ms) between each command.
- Macros are supported in ASCII mode with the {{Name}} notation (case-sensitive). Upon executing, Current value will be substituted.
- Encoder Hostplay does not trigger connect/disconnect events unless in live mode.

Enable N-Act Events Events must be enabled for N-Act to work

Power On Event Test

Protocol: TCP ASCII Address: 127.0.0.1 Port: 50001 Data: Data Delay (ms): 1 Delete

Add new...

Video Cable Connected Event Trigger Delay: 1 Test

Protocol: TCP ASCII Address: 127.0.0.1 Port: 50001 Data: Data Delay (ms): 1 Delete

Add new...

Video Cable Disconnected Event Trigger Delay: 1 Test

Protocol: TCP ASCII Address: 127.0.0.1 Port: 50001 Data: Data Delay (ms): 1 Delete

Add new...

Generic Events AudioChannelCount Add Generic Event

Save Events

Import/Export

Import Choose File No file chosen Import N-Act

Export Export Saved N-Act

AMX | 256.461.7143 | svsisupport@harman.com

FIG. 55 N-Act Page

TABLE 32 N-Act Page Options

Option	Description
Enable N-Act Events	Enable to activate the configured events.
Power on Event	Create/delete/test events to be performed when the Decoder powers on. Visit our website for more details on Application Programming Interface (API) commands.
Video Cable Connected Event	Create/delete/test events to be performed when the Decoder is connected to an output display. The Trigger Delay field specifies how long the device has to be connected for the command to be executed.
Video Cable Disconnected Event	Create/delete/test events to be performed when the Decoder is disconnected from the output display. The Trigger Delay field specifies how long the device has to be disconnected for the command to be executed. This keeps accidental (momentary) disconnects from triggering the command sequence.
Generic Events	Create custom N-Act events. These can be based on most web page or status changes for the unit. NOTE: An Address of 127.0.0.1 basically means to perform the event to THIS unit (on which the N-Act event is being configured).
Save Events	Click to save changes made to this page.
Import/Export	Use this section of the page to import/export N-Act event configurations. from one N-Series unit to other N-Series units.

Serial Page

Click the **Serial** link at the top of any of the main web pages to access the page shown in [Figure 56](#). This page allows you to upload and execute commands used for direct control of serial devices. Commands may be saved for future use and executed later. The **Serial Code** menu lists all saved commands. See [Table 33](#) for option descriptions.

NOTE: *If the Port 5004/Serrial Port is currently in use by another device, sending commands from the Serial page will always return a No Data message and fail to send the commands.*

FIG. 56 Serial Page

TABLE 33 Serial Page Options

Option	Description
Serial Code	Create/select serial commands. Different vendors have different codes that can usually be found through a web search. Copy/paste new commands (in either ASCII or HEX) directly into the appropriate input space. To create a new code, select [New] from this drop-down, replace the content in the white box, enter a name, and click the Save button.
Save	Save the current code.
Delete	Delete the current code.
Execute	Send the selected code out the Decoder's serial connection.
ASCII and HEX	Paste serial commands directly into either the ASCII or HEX field.
Response	View responses provided by the device receiving the serial command(s).

Security Page

Click the **Security** link at the top of any of the main web pages to access the page shown in [Figure 57](#). This page allows you to customize the security settings on your unit. See [Table 34](#) for option descriptions.

The screenshot shows the Security Page for an N-Series 2400 Decoder. The page title is "N-Series 2400 Decoder | N2400 Decoder". The navigation menu includes: Settings, HostPlay, IR, N-Act, Serial, Security (highlighted), KVM, EDID, Logs, LLDP, NetLinX, and AES67. The Security page is divided into three main sections:

- General Security:**
 - Force HTTPS Connection
 - Change Stream Encryption Password: [input field] [Reset]
- Command Port Security:**
 - Secure Ports Only
 - Change Command Password: [input field]
- 802.1X Port Security:**
 - Enable
 - Status: Disabled
 - Configuration: Simple (dropdown)
 - Change 802.1x User Name: [input field]
 - Change 802.1x Password: [input field]

At the bottom of each section are "Cancel" and "Save" buttons. The footer of the page displays: AMX | 256.461.7143 | sysisupport@harman.com

FIG. 57 Security Page

TABLE 34 Security Page Options

Option	Description
General Security	
Force HTTPS Connection	Enable to force web page accesses to always be HTTPS.
Change Stream Encryption Password	Set the default password for stream encryption. To successfully communicate, the Decoder and Encoder passwords must match. Click Reset to return to default password and settings.
Command Port Security	
Secure Ports Only	If enabled, commands must be sent using secure sockets (TLS/SSL) and follow the secure command port protocol.
Change Command Password	Set the default password for command encryption. When issuing API commands, this password must precede each command in the format: <password>\r<command>.
802.1X Port Security	
Enable checkbox	Click to turn on 802.1X security.
Status	Displays status of the current port connection as either Disabled , Authorized , or Unauthorized .
Configuration	Select Simple or Custom . Use Simple for configurations that require only a user name and password. Use Custom for more advanced configurations.

TABLE 34 Security Page Options

Option	Description
Change 802.1x User Name/Password	Enter a new user name and password to use for 802.1x security. They are used when negotiating a secure port with the network. These settings are available only when Configuration is set to Simple .
Custom Config File	Upload a custom wpa_supplicant.conf file. See your network administrator for details. This option is available only when Configuration is set to Custom .

KVM Page

Click the **KVM** link at the top of any of the main web pages to access the N-Series **KVM** page. You must check the **USB Enable** box at the top to see the page shown in [Figure 58](#). See [Table 35](#) for option descriptions.

The screenshot shows the KVM configuration page for an N-Series 2422 Decoder. The page is titled "N-Series 2422 Decoder | epp N2422" and has a navigation menu with options like Settings, Crop/Pan/Zoom, LocalPlay, IR, N-Act, Serial, Security, KVM, EDID, Logs, LLDP, NetLinX, and AES67. The main content area is divided into several sections:

- USB Connection:** Includes a checked "USB Enable" checkbox and a "Permission Level" input field set to 0. A "Save" button is present.
- Connect to Encoder IP Address:** Features an "IP Address" input field with the value 169.254.195.71, and "Switch" and "Disconnect" buttons.
- KVM Advanced Settings:** Includes a checked "Enable" checkbox. Below it is a "KVM Encoders" section with a list box containing two entries: "1:some (169.254.234.24)" and "2:other (169.254.195.71)". To the right of the list box is a "KVM Hotkey Enable" checked checkbox, followed by input fields for "Name", "IP Address", and "Hotkey Number", and a "Change Password to Use" input field. Below these are "Add / Overwrite" and "Remove Encoder" buttons. A "Remove" button is also located below the list box.
- Import/Export:** Contains "Import KVM CSV" and "Export KVM CSV" sections. The "Import KVM CSV" section has a "Choose File" button, the text "No file chosen", and an "Upload" button. The "Export KVM CSV" section has a "Download KVM CSV Export" link.

At the bottom of the page, there is a "Reset USB and KVM Settings" button and a footer with the text "AMX | 256.461.7143 | svsisupport@harman.com".

FIG. 58 KVM Page

TABLE 35 KVM Page Options

Option	Description
USB Enable	Enable to allow the ability to share mouse and keyboard over the network. Enabled by default. When disabled, the unit works like a non-KVM unit and ignores any keyboard or mouse activity.
Permission Level	Set the permission level for the Decoder. Decoders can only establish USB connection to Encoders with the same or higher permission level.
Connect to Encoder IP Address	Enter the IP address of the Encoder you would like to communicate with through this Decoder. Use the Switch button to activate connection and the Disconnect button to deactivate it.
KVM Advanced Settings	Enable to access the KVM Encoders list and the related options.

TABLE 35 KVM Page Options (Cont.)

Option	Description
KVM Encoders	View/edit the list of Encoders associated with this Decoder. Here you can Add/Overwrite Encoders to the list by Name or IP Address as well as assign Passwords , and Hotkey Numbers (explained below). You can also end the Decoder/Encoder association by clicking the Remove Encoder button. Intended for use when different passwords are assigned to Encoders in your system.
KVM Hotkey Enable	Enable to allow the unit to respond to Encoder hotkey assignments, allowing for easy switching via the keyboard connected to the Decoder. Assign Hotkey Numbers to the Encoders in the KVM Encoders list. Once the numbers are assigned, you can switch to a different Encoder using the keyboard connected to the Decoder. Press the <Scr Lk> key twice, followed by the assigned Hotkey Number , and <Enter> . To return to Local Play, press the <Scr Lk> key twice, followed by 0 , and <Enter> .
Import KVM CSV	Click the Choose File button and browse to the KVM CSV file on your computer that you would like to use to configure the unit. Then click Upload .
Export KVM CSV	Click the Download KVM CSV Export link to retrieve the current KVM CSV configuration file.
Reset USB and KVM Settings	Resets all USB and KVM settings.

EDID Page

Click the **EDID** link at the top of any of the main web pages to access the page shown in [Figure 59](#). Every display has stored information that it communicates to the output device. This page allows you to view the EDID information of the connected output display.

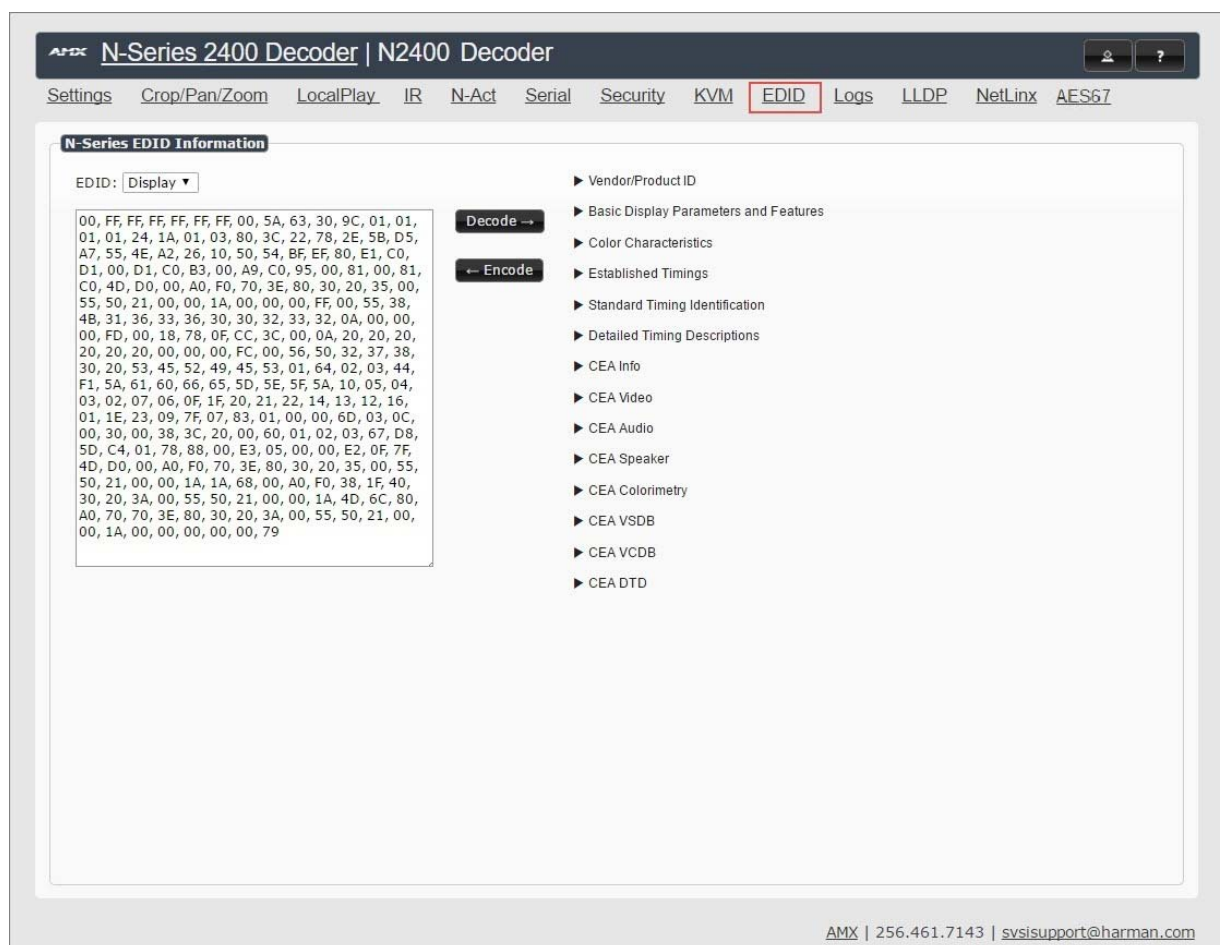

FIG. 59 EDID Page

TABLE 36 EDID Page Options

Option	Description
EDID Display	Shows the EDID of the display that is connected to the Decoder.

TABLE 36 EDID Page Options (Cont.)

Option	Description
Decode button	Click to translate the EDID currently displayed on the left to the operating parameters list on the right.
Encode button	After making any changes to the operating parameters list on the right, click this button to update the EDID information on the left.

Logs Page

Click the **Logs** link at the top of any of the main web pages to access the page shown in [Figure 60](#). The **Logs** page displays a command log that lists all TCP and UDP messages the unit receives. It also displays the web browser's IP address and gives you options to **Refresh** and **Reset Logs**. When in need of assistance from tech support, you can use the Debug Log section to capture useful troubleshooting information. Simply click the Start Debug Log button, wait at least one minute, and click the End Debug Log button to create the file. You can then download and send it to AMX tech support.

AMX N-Series 2400 Decoder | N2400 Decoder

Settings Crop/Pan/Zoom LocalPlay IR N-Act Serial Security KVM EDID **Logs** LLDP NetLinx AES67

Your IP address is 169.254.55.86 Refresh Logs Reset Logs

Command Log

Elapsed Time	IP	Port	Method	Command
5 min, 44 sec	Web page	50003	TCP	scalerdisable\r
6 min, 31 sec	Web page	50003	TCP	scalerenable\r
6 min, 42 sec	Web page	50003	TCP	scalerdisable\r
6 min, 56 sec	Web page	50003	TCP	scalerenable\r
2 days, 17 hrs, 19 min, 39 sec	Web page	50003	TCP	scalerdisable\r
2 days, 17 hrs, 19 min, 50 sec	Web page	50003	TCP	scalerenable\r

Debug Log

Start Debug Log End Debug Log Debug log not ready. Refresh page.

Enable Maintenance Mode

AMX | 256.461.7143 | sysisupport@harman.com

FIG. 60 Logs Page

NOTE: For security reasons, only use the Enable Maintenance Mode if instructed by AMX Technical Support. This selection only appears in the secure version of the website (i.e., [https](#)).

LLDP Page

Click the **LLDP** link at the top of any of the main web pages to access the page shown in [Figure 61](#). The **LLDP** page displays information from the Link Layer Discover Protocol (LLDP) packet which identifies the port number and switch the device is connected to.

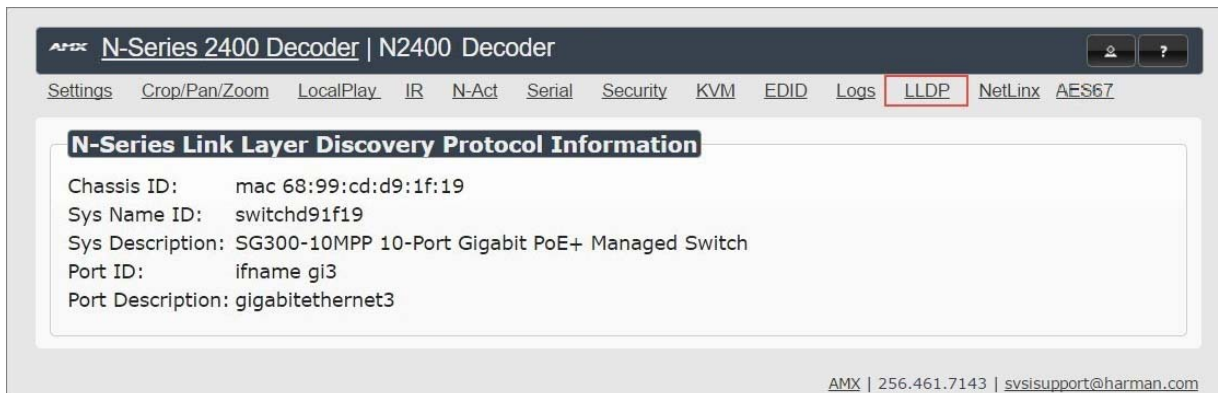

FIG. 61 LLDP Page

NetLinx Page

Click the **Netlink** link at the top of any of the main web pages to access the page shown in [Figure 62](#). Options are described in [Table 37](#). This page allows you to prepare your N2400 for NetLinx-driven configuration. This is explained in more detail in [Appendix A: NetLinx Control](#), on page 71.

NOTE: *NetLinx takes over the Serial port when active.*

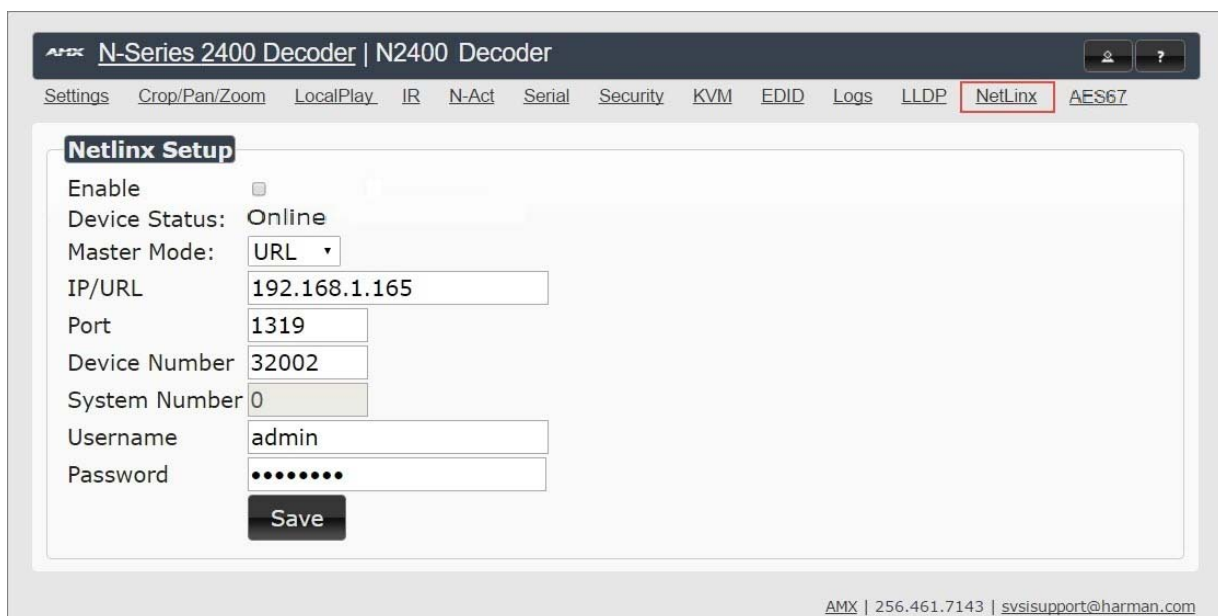

FIG. 62 NetLinx Page

TABLE 37 NetLinx Page Options

Command	Description
Enable	Click to enable/disable NetLinx on this device.
Device Status	This status field will show the device to be Online , Connected , Offline , or Unknown .
Master Mode	Select Auto , Listen , or URL .
IP/URL	Enter the address of the Master Controller.

TABLE 37 NetLinX Page Options (Cont.)

Command	Description
Port	This field should always be set to 1319 .
Device Number	Defaults to a dynamic device number. May be set to a static range (e.g., 8000).
System Number	Determines which system to connect. This setting is dependent upon the Master Mode selected (see above). <ul style="list-style-type: none"> If Master Mode is set to Auto, the System Number is set and the system discovers the Master Controller's IP address. If Master Mode is set to Listen, the device connects to any Master Controller. If Master Mode is set to URL, the IP of the Master Controller is set.
Username	Username for the Master Controller.
Password	Password for the Master Controller.
Save button	Click to save settings made on this page.

AES67 Page

Click the **AES67** link at the top of any of the main web pages to access the page shown in [Figure 63](#). Options are described in [Table 38](#). AES67 is an open standard for audio over IP and audio over Ethernet. This page allows you to configure the Encoder to generate AES67 audio and send it to devices that support it.

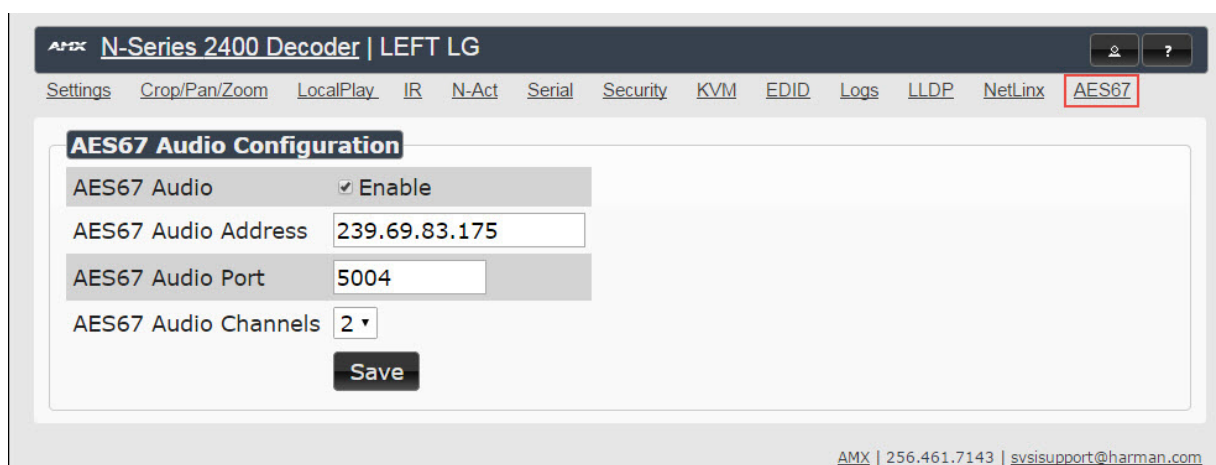
**FIG. 63** AES67 Page**TABLE 38** AES67 Page Options

Command	Description
AES67 Audio	Enable to turn on AES67 audio and turn off other audio streams.
AES67 Audio Address	Enter the IP address of the AES67 audio source you want to use. The address's first octet must start with 239 (e.g., 239.xxx.xxx.xxx). It will not work with other numbers for the first octet.
AES67 Audio Port	Enter the audio port number you want to use.
AES67 Audio Channels	Select the number of audio channels to be sent to the Decoder from the AES67 stream.
Save button	Click to save settings made on this page.

Chapter 5: Troubleshooting

This chapter contains possible solutions to some common issues. Should you encounter any problems not covered by these guidelines, please contact SVSI technical support via email (svsisupport@harman.com) or call 256.461.7143 x9900.

Issues	Suggestions
LocalPlay screen displays instead of the stream from the Encoder.	<ul style="list-style-type: none"> • Verify Decoder is assigned to view a valid stream (of an active Encoder). • Verify Decoder is currently in Live play mode (its name will display in black text on the Video Matrix page). You can change to Live mode on the Settings page (see the Settings Page: Decoder Setup Section table on page 46 for more details). • Verify network is properly configured and set up. If needed, connect Encoder's network port to Decoder to bypass the network.
HostPlay screen displays instead of the video from the source.	<ul style="list-style-type: none"> • Verify Encoder is in Live play mode (its name will display in black text on the Video Matrix page). You can change to Live mode on the Settings page (see Settings Page: Encoder Setup Section table on page 25 for more details). • Verify source is attached and is outputting a valid signal (HDMI LED on Encoder is on).
Unsupported Input Resolution screen displays.	<ul style="list-style-type: none"> • Change source resolution to a valid resolution (try 720p60). • Verify cabling is correct.
Copy Protected Content screen displays.	<ul style="list-style-type: none"> • Contact technical support.
Black screen/no screen displays.	<ul style="list-style-type: none"> • Set Decoder to LocalPlay. If the LocalPlay screen does not appear, check the display input settings and cabling. As mentioned previously in this table, you can change to the Local mode on the Decoder's Settings page. • If LocalPlay appears, set Decoder to Live play mode and verify network is configured properly. • Check the Decoder's LocalPlay status. If Loading is displayed, allow some extra time for LocalPlay to become active.
No audio is detected.	<ul style="list-style-type: none"> • If there is no audio on <u>all</u> Decoders, verify audio settings are correct on Encoder. • If there is no audio on a <u>single</u> Decoder, verify audio settings are correct on Decoder.
Device has been discovered in N-Able, but the configuration pages do not open when double-clicking device name on the Video Matrix page.	<ul style="list-style-type: none"> • Make sure your computer is in the same IP address range as the unit. See : <i>Setting Up Your Host Computer</i> on page 12 for more information.
When changing the audio type, there are problems with audio in/out.	<ul style="list-style-type: none"> • Check the Audio Source (Encoder) and Enable HDMI Audio (Decoder) settings on the Settings page. For example, if you are trying to change the audio type to make the input of the Encoder HDMI embedded audio in/analog audio out from the Decoder, these settings cannot be set to Auto. Set the Encoder to Audio Source > ON (embedded digital audio on an HDMI connection) and the Decoder to Enable HDMI Audio > OFF (analog output on the Phoenix connection).
Not receiving audio.	<ul style="list-style-type: none"> • Check that the Decoder has proper audio stream setting (typically by enabling Audio follows Video). • Verify that the AES67 settings are correctly configured (e.g., AES67 Audio Address is correct and the first octet of the address is 239). Also, the AES67 Audio option must match between the Encoder and Decoder. See <i>AES67 Page</i> section on page 43 for more details.
Not receiving analog video through the Encoder.	<ul style="list-style-type: none"> • If using a Y cable (N9420) and an HDMI source is already connected to the Encoder, disconnect the HDMI source. Encoders give preference to HDMI and will not allow analog signal to pass while it is connected.
Video output is stuttering.	<ul style="list-style-type: none"> • This could be a network bandwidth issue where the full video stream is not reliably getting from Encoder to Decoder. Contact your network administrator for assistance.
Experiencing a red/blue color swap.	<ul style="list-style-type: none"> • Check Gen1 Compatibility Mode. If the entire system is N-Series, set to Off. If the system is mixed (V-Series and N-Series), set to On for the N-Series Decoder. See <i>Advanced Settings</i> on page 48 for more information on this mode.
Serial port is not working as expected.	<ul style="list-style-type: none"> • Verify the RS232 Settings on the Settings page. Flush the serial port on the Settings page if another device is connected. • Connecting the Tx and Rx pins on the RS232 connector creates a loopback that could also help when troubleshooting. <p>NOTE: <i>NetLinx takes over the Serial port when active.</i></p>

Series Default Local/Host Play Troubleshooting Screens

This section shows and defines the status screens displayed by N2400 Series devices.



FIG. 64 Host Play Screen

Displayed when Decoder...	...and Encoder...	Notes
<ul style="list-style-type: none"> is set to view an Encoder stream on the network 	<ul style="list-style-type: none"> is set to HostPlay, or does NOT have a valid input video signal 	<p>Seeing this screen means that the Decoder CAN communicate with the Encoder across the network. It is a good way to troubleshoot network communication between segments using only Encoders and Decoders (without the need for source video into an Encoder).</p>



FIG. 65 Local Play Screen

Displayed when Decoder...	Notes
<ul style="list-style-type: none"> is set to LocalPlay mode 	<p>If the Decoder is NOT set to Local Play mode, this screen could signify a network communication issue.</p>



FIG. 66 Unsupported Input Resolution Screen

Displayed when Decoder...	...and Encoder...	Notes
<ul style="list-style-type: none"> is set to view an Encoder stream on the network 	<ul style="list-style-type: none"> is being fed a video resolution that it does not support 	<p>This screen can be useful to show you that the Decoder is receiving the stream from the intended Encoder. However, the video signal being sent to the Encoder is not supported. Please refer to the AMX website at www.amx.com for supported resolutions lists.</p>



FIG. 67 Restricted Content Not Supported Screen

Displayed when Decoder...	...and Encoder...	Notes
<ul style="list-style-type: none"> is receiving a stream from an Encoder is connected to a monitor that does NOT support Restricted Content (i.e., the monitor is NOT HDCP compliant) 	<ul style="list-style-type: none"> is transmitting HDCP-protected content to the Decoder 	<p>Once the Decoder detects that the monitor is not HDCP compliant, this screen is displayed. If you suspect that this message was displayed in error, please call Technical Support.</p>

NOTE: *The Encoder must first be set up to pass HDCP-protected content.*



FIG. 68 Video Encrypted Screen

Displayed when Decoder...	Notes
<ul style="list-style-type: none"> is receiving a stream from an Encoder it cannot decrypt 	<p>Make sure the Decoder has the correct password for decrypting the stream. To reset the password, go to the Security page on both the Encoder and Decoder and click the Reset button. Refer to the <i>Security Page</i> section on page 60 if you are not sure where to find this setting.</p>

Appendix A: NetLinx Control

Introduction

NetLinx Studio is a Microsoft Windows program commonly used by system programmers to streamline the integration, programming, organization, and support of AMX equipment. As the cornerstone of AMX's system design software tools, NetLinx Studio offers programmers the most flexible application capable of generating the most sophisticated code possible. Now equipment in our latest N-Series Networked AV Product Lines comes equipped with NetLinx support. This appendix introduces the new configuration aspects necessary to bring all of your NetLinx-compatible equipment up to speed with the latest functionality and covers NetLinx functionality as it applies to AMX's N-Series product line.

NetLinx Configuration Using the Unit's Webpage

From any main page of the unit webpage, click the **NetLinx** tab. See [Figure 69](#). [Table 39](#) provides descriptions for each configuration option.

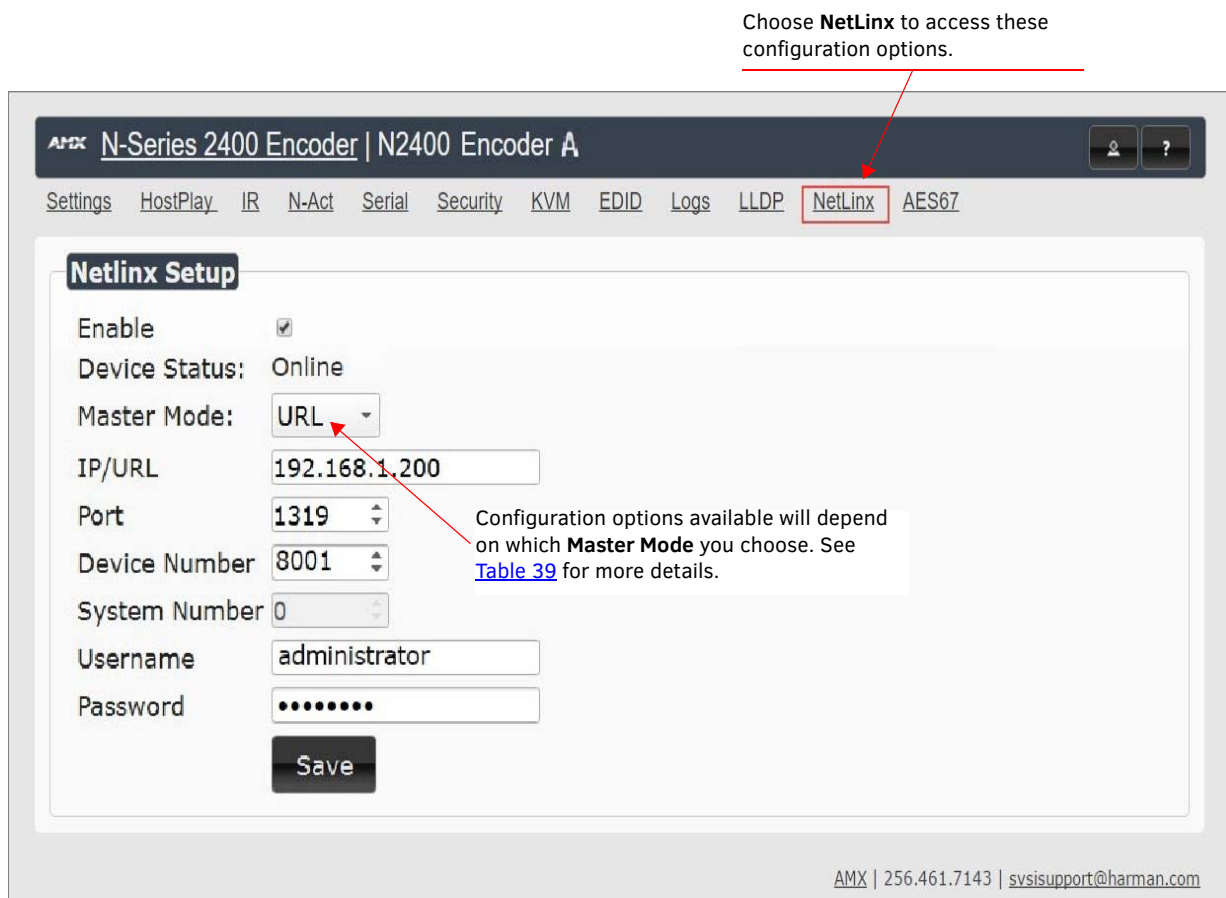

FIG. 69 NetLinx Configuration Page

TABLE 39 NetLinx Configuration Options

Command	Description
Enable	Click to enable/disable NetLinx on this device.
Device Status	This status field will show the device to be Online , Connected , Offline , or Unknown .
Master Mode	Select Auto , Listen , or URL .
IP/URL	Enter the address of the Master Controller.
Port	This field should always be set to 1319 .
Device Number	Defaults to a dynamic device number. May be set to a static range (e.g., 8000).
System Number	Determines which system to connect. This setting is dependent upon the Master Mode selected (see above). <ul style="list-style-type: none"> If Master Mode is set to Auto, the System Number is set and the system discovers the Master Controller's IP address. If Master Mode is set to Listen, the device connects to any Master Controller. If Master Mode is set to URL, the IP of the Master Controller is set.

TABLE 39 NetLinX Configuration Options (Cont.)

Command	Description
Username	Username for the Master Controller.
Password	Password for the Master Controller.
Save	Save settings made on this page.

Batch Configurations Using N-Able

One of the many benefits of using N-Able control is batch configuration. This is especially useful in larger deployments. Instead of using the individual unit web pages (discussed in the previous section), simply open N-Able and select **Tools > Batch Config**. See [Figure 70](#).

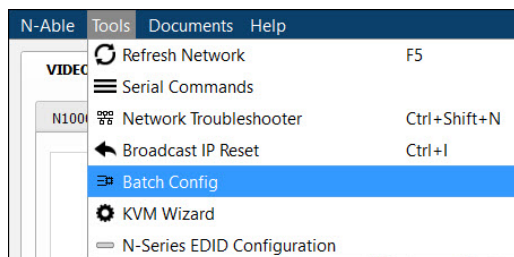

FIG. 70 Selecting Batch Config in N-Able

The screen shown in [Figure 71](#) displays and allows you to choose the units you would like to enable for NetLinX control. To select multiple units, hold down the <Ctrl> key. Once all of the units are selected, enable **NetLinX On** and click the **OK** button at the bottom of the screen.

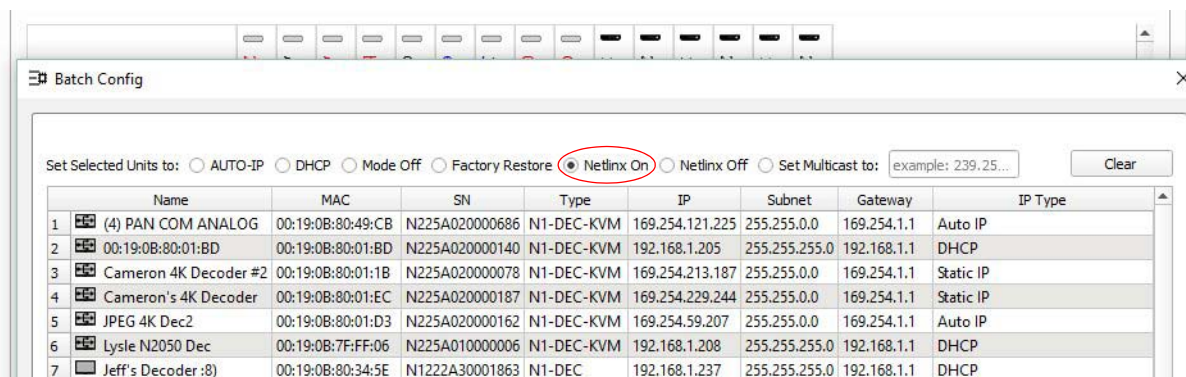

FIG. 71 Enabling NetLinX on Multiple Units

NOTE: Items are not filtered. In other words, if you send a NetLinX command to a device that does not support it, the command is simply ignored.

Encoder/Decoder Commands

The following section provides information on native, string, IR, and serial commands for N-Series Encoders and Decoders as related to NetLinX management. Commands are issued on the following ports:

- Port 1: Native and String Commands
- Port 2: IR Commands
- Port 3: Serial Commands

Native Commands Port 1

Command	Description
CO <stream> Set the current Encoder stream number.	IMPORTANT: <i>This command must be sent to D:P:S port 1.</i> Syntax: SEND_COMMAND <DEV>, 'CO <stream>' Variables: stream = The target stream number from 1 to 32767. NOTE: <i>Stream number MOD 256 must not equal 0 or 255.</i> Examples: SEND_COMMAND 5002:1:0, 'CO 2' Command the Encoder to transmit on stream 2.
CI <stream> Set the current Decoder stream number.	IMPORTANT: <i>This command must be sent to D:P:S port 1.</i> Syntax: SEND_COMMAND <DEV>, 'CI <stream>' Variables: stream = The target stream number from 0 to 32767. NOTE: <i>Stream number MOD 256 must not equal 0 or 255. The only exception to this limitation is that the stream number can be 0 (no stream).</i> Examples: SEND_COMMAND 5002:1:0, 'CI 2' Command the Decoder to receive stream 2.
CA <stream> Set the current Decoder Audio stream number.	IMPORTANT: <i>This command must be sent to D:P:S port 1.</i> Syntax: SEND_COMMAND <DEV>, 'CA <stream>' Variables: stream = The target stream number from 0 to 32767. Set to 0 for the audio stream to follow the video stream. Examples: SEND_COMMAND 5002:1:0, 'CA 2' Command the Decoder to receive audio stream 2.
AUDOUT_MUTE Set the audio mute.	IMPORTANT: <i>This command must be sent to D:P:S port 1.</i> Syntax: SEND_COMMAND <DEV>, 'AUDOUT_MUTE-<ENABLE DISABLE>' Variables: ENABLE = Enables audio mute. DISABLE = Disables audio mute. Examples: SEND_COMMAND 5002:1:0, 'AUDOUT_MUTE-ENABLE' Enable audio mute.
VIDOUT_MUTE Disable the Encoder/Decoder output stream.	IMPORTANT: <i>This command must be sent to D:P:S port 1.</i> Syntax: SEND_COMMAND <DEV>, 'VIDOUT_MUTE-<ENABLE DISABLE>' Variables: ENABLE = Enables video mute. DISABLE = Disables video mute. Examples: SEND_COMMAND 5002:1:0, 'VIDOUT_MUTE-ENABLE' Enable video mute.
LIVE_PLAY Set the device into live play mode.	IMPORTANT: <i>This command must be sent to D:P:S port 1.</i> Syntax: SEND_COMMAND <DEV>, 'LIVE_PLAY' Examples: SEND_COMMAND 5002:1:0, 'LIVE_PLAY' Enable live play.

Native Commands Port 1 (Cont.)

Command	Description
LOCAL_PLAY <Playlist index> Enable Local Play on Decoders or Host Play on Encoders using the Playlist number.	IMPORTANT: <i>This command must be sent to D:P:S port 1.</i> Syntax: SEND_COMMAND <DEV>, 'LOCAL_PLAY index' Variables: Playlist index = Which Default Playlist index to enable. Examples: SEND_COMMAND 5002:1:0, 'LOCAL_PLAY 1' Enable local play with Default Playlist 1.
USB_HID_SERVICE Enable or disable USB.	IMPORTANT: <i>This command must be sent to D:P:S port 1.</i> Syntax: SEND_COMMAND <DEV>, 'USB_HID_SERVICE-<ENABLE DISABLE>' Variables: ENABLE = Enables USB. DISABLE = Disables USB. Examples: SEND_COMMAND 5002:1:0, 'USB_HID_SERVICE-ENABLE' Enable USB.
REBOOT Reboot the device.	Syntax: SEND_COMMAND <DEV>, 'REBOOT' Variables: None Examples: SEND_COMMAND 5002:1:0, 'REBOOT' Reboots the device.
?VIDOUT_OUTPUT Request the Encoder current stream number.	Syntax: SEND_COMMAND <DEV>, '?VIDOUT_OUTPUT' Examples: SEND_COMMAND 5002:1:0, '?VIDOUT_OUTPUT' Command Response: 'VIDOUT_OUTPUT-852'
?VIDIN_INPUT Request the Decoder current stream number.	Syntax: SEND_COMMAND <DEV>, '?VIDIN_INPUT' Examples: SEND_COMMAND 5002:1:0, '?VIDIN_INPUT' Command Response: 'VIDIN_INPUT-852'
?AUDOUT_MUTE Request the state of the audio mute.	Syntax: SEND_COMMAND <DEV>, '?AUDOUT_MUTE' Examples: SEND_COMMAND 5002:1:0, '?AUDOUT_MUTE' Command Response: 'AUDOUT_MUTE-ENABLE'
?VIDOUT_MUTE Request the state of the Encoder stream transmission.	Syntax: SEND_COMMAND <DEV>, '?VIDOUT_MUTE' Examples: SEND_COMMAND 5002:1:0, '?VIDOUT_MUTE' Command Response: 'VIDOUT_MUTE-DISABLE'
?LIVE_PLAY Request the status of Live Play.	Syntax: SEND_COMMAND <DEV>, '?LIVE_PLAY' Examples: SEND_COMMAND 5002:1:0, '?LIVE_PLAY' Command Response: 'LIVE_PLAY-live' or 'LIVE_PLAY-local'

Native Commands Port 1 (Cont.)

Command	Description
?LOCAL_PLAY Request the Local Play/Host Play Playlist number.	Syntax: SEND_COMMAND <DEV>, '?LOCAL_PLAY' Examples: SEND_COMMAND 5002:1:0, '?LOCAL_PLAY' Command Response: 'LOCAL_PLAY-1'
?USB_HID_SERVICE Request the status of the USB.	Syntax: SEND_COMMAND <DEV>, '?USB_HID_SERVICE' Examples: SEND_COMMAND 5002:1:0, '?USB_HID_SERVICE' Command Response: 'USB_HID_SERVICE-<0 1>'

IR/Serial Send Commands Port 3

Command	Description
GET BAUD Get the RS-232 port's communication parameters.	Syntax: SEND_COMMAND <DEV>, 'GET BAUD' Example: SEND_COMMAND 5002:3:0, 'GET BAUD' Command Response: 'GET-9600,N,8,1'
SET BAUD Set the RS-232 port's communication parameters.	Syntax: SEND_COMMAND <DEV>, 'SET BAUD <baud>,<parity>,<data>,<stop>' Variables: baud = baud rates are: 115200, 57600, 38400, 19200, 9600, 4800, 2400, 1200. parity = N (none), O (odd), E (even). data = 8 data bits. stop = 1 and 2 stop bits. Example: SEND_COMMAND 5002:3:0, 'SET BAUD 9600,N,8,1' Command Response: 'SET- BAUD 9600,N,8,1'

Pass Through Commands

For other commands, the NetLinx String command will interpret any existing N-Series API command. For example, to enable the scaler, send the following string command:

```
SEND_STRING <DEV>, 'scalerenable'
```

Similarly, to disable the scaler, send the string command:

```
SEND_STRING <DEV>, 'scalerdisable'
```

The response to a pass through string command is the issued command followed by the status message. For example:

- Command string:

```
SEND_STRING <DEV>, 'scalerenable'
```

- Response string

```
"scalerenable-SVSI_RXGEN2:N225A020000140',A,'NAME:00:19:0B:80:01:BD',A,'MAC:00:19:0B:80:01:BD'..."
```

NOTE: Multiple commands cannot be issued together separated by '\r'.

For more information, refer to the API documentation for the N-Series device.

IR Port 2

Using the NetLinX Studio application, download the appropriate IR file to the N-Series device to use the appropriate channels. Port 2 is used to send IR commands. Some tuning of the NetLinX **Pulse Time**, **IR Command Holdoff**, and **IR Repeat Holdoff** on the N-Series device may be required. The Pulse Time is controlled in the SNAPY code. The **IR Command Holdoff** and the **IR Repeat Holdoff** are controlled on the **Advanced** section of the N-Series device **Settings** web page. See [Figure 72](#) to see where to find these options.

IR Command Holdoff

- This is the delay between IR commands portions.
- To set the IR Command Holdoff, issue the following string command:
SEND_STRING <DEV>, 'setSettings:ircmdtime:<time in ms>'
- The default value is 25 ms.

IR Repeat Holdoff

- This is the repeat delay between IR commands.
- To set the IR Repeat Holdoff, issue the following string command:
SEND_STRING <DEV>, 'setSettings: irc2rtime:<time in ms>'
- The default value is 90 ms.

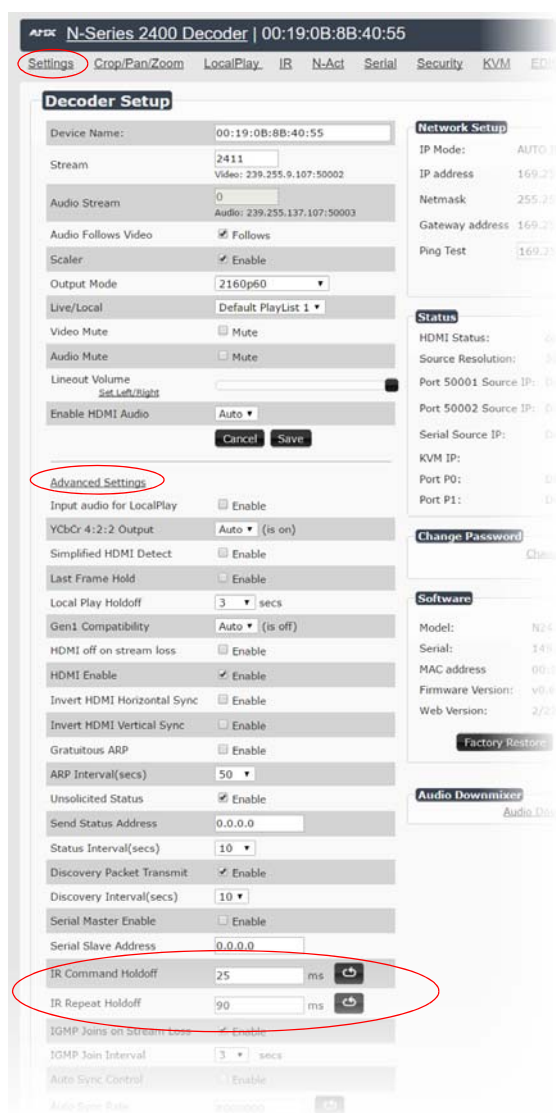

FIGURE 72 Advanced IR Port Settings

Serial Port 3

Port 3 is used for serial commands. Any string sent with the send string command will be output through the serial port. Data returned from the serial port will be from the device also on port 3.

Appendix B: Minimum Network Requirements

As you look into an N-Series solution and try to decide what type of network topology and infrastructure will be best suited for your application, there are some minimum network requirements that must be considered when choosing the hardware to deploy a Networked AV system. The requirements presented in this guide cover the necessary protocols and features needed to drive an N-Series stream.

NOTE: Specific configuration recommendations given in this document are based off of the Cisco Catalyst series switch. These recommendations could vary from manufacturer to manufacturer.

1. Managed Network Switch
2. Gigabit Ethernet (N1000/N2000 Based Systems)
3. Internet Group Management Protocol (IGMP) Version 2
 - a. IGMP Snooping
 - i. Snooping must be enabled on all switches that are communicating with the querier.
 - b. IGMP Snooping Querying
 - i. Network must include at least one IGMP Querier to maintain stream connections.
 1. It is recommended to have all capable switches with the querier enabled and allow IGMP auto-elect to determine the Designated Querier (DQ).
 - a. DQ is determined by the lowest IP addressed switch, but can be manually assigned. However, this would need to be manually configured on all switches to bypass the auto-elect.
 - ii. Query interval – 30s
 1. Interval between sending IGMP general queries.
 - iii. Query Response Interval – 10s
 1. The maximum time the system waits for a response to general queries.
 - iv. Last Member Query Interval – 100ms
 1. The interval to wait for a response to a group specific or group-and-source-specific query message.
 - v. Immediate Leave (required for N1000, N2x51 4K, N2300 4K, N2400, and N2x35 [Extreme Quality] Low Latency Models)
 1. Used to immediately break up multi-cast groups when a leave message is received.
 2. Immediate Leave will break any daisy chaining of multiple units together with a single home run and as such you will not be able to have both Immediate Leave and daisy chaining in the same VLAN.
 3. Some manufacturers do not have Immediate Leave as an option and use Fast Leave instead.
 - a. Fast Leave does not guarantee an immediate leave from the multi-cast group and can affect switching speeds and performance.
 - vi. Optional Protocols
 1. IGMP Robustness – Default 2
 - a. Robustness can be adjusted generally from 2-10. The higher the value, the more leave latency is added.
 - b. This protocol is effectively inactive when Immediate Leave is enabled.
 - c. Warnings/Notices
 - i. There is a known behavior within IGMP V2 that Encoder streams, whether requested across an uplink or not, will be requested by the DQ and will be present on the uplinks of all switches between the stream source switch and the DQ.
 1. Essentially this means that even though you may not be routing a stream to another switch, the DQ's request will still put the stream on the uplink. Therefore, ensure that you have accounted for all streams forwarding to the DQ.
 2. A good rule of thumb, when planning for bandwidth considerations on uplinks, is to not exceed 80% of the uplink's total bandwidth capacity to give plenty of overhead for spikes and additional traffic.
 3. Multicast routing capabilities on each switch (configured for PIM-SM and with an established rendezvous point) can be designed to limit or mitigate this behavior.
 - ii. When a multicast host leaves a group, it sends an IGMP leave message. When the leave message is received by the switch, it checks to see if this host is the last to leave the group by sending out an IGMP group-specific or group-and-source specific query message, and starting a timer. If no reports are received before the timer expires, the group record is deleted and a report is sent to the upstream multicast router/querier switch. Lower interval times will increase bandwidth utilization slightly as querying will happen more often.
4. Protocol Independent Multicast (PIM)
 - a. Used to route multicast between VLANs
 - b. PIM Sparse Mode (PIM-SM)
 - i. Recommended for use with N-Series multicast products.
 - ii. PIM-SM uses a pull model to deliver multicast traffic. Only network segments with active receivers that have explicitly requested the data will receive the traffic.
 - iii. Requires configuration of a Rendezvous Point (RP).
 1. Must be configured by administrator.
 2. Similar to the DQ in IGMP.
 3. All multicast sources must register with the RP to be able to be routed throughout the network.
 - c. Other PIM modes – not recommended for N-Series
 - i. Dense Mode (PIM-DM)
 - ii. Bidirectional (bidir-PIM)
5. Jumbo Frames Enabled (For N2300 Series)

- a. The N2300 Series Encoders and Decoders produce a frame payload larger than 1500 bytes. This requires the switch to have the capacity of handling jumbo frames enabled.
6. Quality of Service (QoS): Managing the delay, delay variation (jitter), bandwidth, and packet loss parameters on a network becomes the secret to a successful end-to-end business solution.
 - a. Not required for use with N-Series devices
 - b. Policing
 - i. A policer typically drops traffic.
 - ii. Differentiated Services Code Point (DSCP) values can be configured in N-Series devices if QoS is required on the network.
 - c. Shaping
 - i. A shaper typically delays excess traffic using a buffer, or queueing mechanism, to hold packets and shape the flow when the data rate of the source is higher than expected.
 - ii. Cannot be used with N2300 series.
7. TCN Flood Off
 - a. TCN (Topology Change Notification) flooding will cause unnecessary backplane and bandwidth usage when adding or removing a device on the network, which can cause stream interruptions as the flooding sweeps through the network.
 - i. Note that this command has to be assigned individually per port that is assigned to that VLAN. However it is not necessary with ports on the same switch that will not be set up on the same VLAN as the N-Series devices.
 - b. Command Example: NO IP IGMP SNOOPING TCN FLOOD

Should you encounter any problems not covered by these guidelines, please contact technical support via email (svsisupport@harman.com) or call 256.461.7143 x9900.



© 2018 Harman. All rights reserved. AMX, AV FOR AN IT WORLD, and HARMAN, and their respective logos are registered trademarks of HARMAN. Oracle, Java and any other company or brand name referenced may be trademarks/registered trademarks of their respective companies. AMX does not assume responsibility for errors or omissions. AMX also reserves the right to alter specifications without prior notice at any time. The AMX Warranty and Return Policy and related documents can be viewed/downloaded at www.amx.com.
3000 RESEARCH DRIVE, RICHARDSON, TX 75082 AMX.com | 800.222.0193 | 469.624.8000 | +1.469.624.7400 | fax 469.624.7153
AMX (UK) LTD, AMX by HARMAN - Unit C, Auster Road, Clifton Moor, York, YO30 4GD United Kingdom • +44 1904-343-100 • www.amx.com/eu/

Last Revised:
5/2018
850DOCN2400MNREV2.0