



INSTRUCTION MANUAL

SOLECIS DIGITAL SWITCHERS

SDX-410-DX, SDX-510M-DX, SDX-810-DX
SDX-414-DX, SDX-514M-DX



IMPORTANT SAFETY INSTRUCTIONS

1. READ these instructions.
2. KEEP these instructions.
3. HEED all warnings.
4. FOLLOW all instructions.
5. DO NOT use this apparatus near water.
6. CLEAN ONLY with dry cloth.
7. DO NOT block any ventilation openings. Install in accordance with the manufacturer's instructions.
8. DO NOT install near any heat sources such as radiators, heat registers, stoves, or other apparatus (including amplifiers) that produce heat.
9. DO NOT defeat the safety purpose of the polarized or grounding type plug. A polarized plug has two blades with one wider than the other. A grounding type plug has two blades and a third grounding prong. The wider blade or the third prong are provided for your safety. If the provided plug does not fit into your outlet, consult an electrician for replacement of the obsolete outlet.
10. PROTECT the power cord from being walked on or pinched, particularly at plugs, convenience receptacles, and the point where they exit from the apparatus.
11. ONLY USE attachments/accessories specified by the manufacturer.



12. USE ONLY with a cart, stand, tripod, bracket, or table specified by the manufacturer, or sold with the apparatus. When a cart is used, use caution when moving the cart/apparatus combination to avoid injury from tip-over.
13. UNPLUG this apparatus during lightning storms or when unused for long periods of time.
14. REFER all servicing to qualified service personnel. Servicing is required when the apparatus has been damaged in any way, such as power-supply cord or plug is damaged, liquid has been spilled or objects have fallen into the apparatus, the apparatus has been exposed to rain or moisture, does not operate normally, or has been dropped.
15. DO NOT expose this apparatus to dripping or splashing and ensure that no objects filled with liquids, such as vases, are placed on the apparatus.
16. To completely disconnect this apparatus from the AC Mains, disconnect the power supply cord plug from the AC receptacle.
17. Where the mains plug or an appliance coupler is used as the disconnect device, the disconnect device shall remain readily operable.
18. DO NOT overload wall outlets or extension cords beyond their rated capacity as this can cause electric shock or fire.



The exclamation point, within an equilateral triangle, is intended to alert the user to the presence of important operating and maintenance (servicing) instructions in the literature accompanying the product.



The lightning flash with arrowhead symbol within an equilateral triangle is intended to alert the user to the presence of uninsulated "dangerous voltage" within the product's enclosure that may be of sufficient magnitude to constitute a risk of electrical shock to persons.



ESD Warning: The icon to the left indicates text regarding potential danger associated with the discharge of static electricity from an outside source (such as human hands) into an integrated circuit, often resulting in damage to the circuit.

- WARNING:** To reduce the risk of fire or electrical shock, do not expose this apparatus to rain or moisture.
- WARNING:** No naked flame sources - such as candles - should be placed on the product.
- WARNING:** Equipment shall be connected to a MAINS socket outlet with a protective earthing connection.

COPYRIGHT NOTICE

AMX© 2016, all rights reserved. No part of this publication may be reproduced, stored in a retrieval system, or transmitted, in any form or by any means, electronic, mechanical, photocopying, recording, or otherwise, without the prior written permission of AMX. Copyright protection claimed extends to AMX hardware and software and includes all forms and matters copyrightable material and information now allowed by statutory or judicial law or herein after granted, including without limitation, material generated from the software programs which are displayed on the screen such as icons, screen display looks, etc. Reproduction or disassembly of embodied computer programs or algorithms is expressly prohibited.

LIABILITY NOTICE

No patent liability is assumed with respect to the use of information contained herein. While every precaution has been taken in the preparation of this publication, AMX assumes no responsibility for error or omissions. No liability is assumed for damages resulting from the use of the information contained herein. Further, this publication and features described herein are subject to change without notice.

AMX WARRANTY AND RETURN POLICY

The AMX Warranty and Return Policy and related documents can be viewed/downloaded at www.amx.com.

ESD WARNING

	<p>To avoid ESD (Electrostatic Discharge) damage to sensitive components, make sure you are properly grounded before touching any internal materials.</p> <p>When working with any equipment manufactured with electronic devices, proper ESD grounding procedures must be followed to make sure people, products, and tools are as free of static charges as possible. Grounding straps, conductive smocks, and conductive work mats are specifically designed for this purpose. These items should not be manufactured locally, since they are generally composed of highly resistive conductive materials to safely drain static discharges, without increasing an electrocution risk in the event of an accident.</p> <p>Anyone performing field maintenance on AMX equipment should use an appropriate ESD field service kit complete with at least a dissipative work mat with a ground cord and a UL listed adjustable wrist strap with another ground cord.</p>
---	---

	<p>WARNING: Do Not Open! Risk of Electrical Shock. Voltages in this equipment are hazardous to life. No user-serviceable parts inside. Refer all servicing to qualified service personnel.</p> <p>Place the equipment near a main power supply outlet and make sure that you can easily access the power breaker switch.</p>
---	---

WARNING: This product is intended to be operated ONLY from the voltages listed on the back panel or the recommended, or included, power supply of the product. Operation from other voltages other than those indicated may cause irreversible damage to the product and void the products warranty. The use of AC Plug Adapters is cautioned because it can allow the product to be plugged into voltages in which the product was not designed to operate. If the product is equipped with a detachable power cord, use only the type provided with your product or by your local distributor and/or retailer. If you are unsure of the correct operational voltage, please contact your local distributor and/or retailer.

WARNING: Avoid exposure to extreme heat or cold.

FCC AND CANADA EMC COMPLIANCE INFORMATION:

This device complies with part 15 of the FCC Rules. Operation is subject to the following two conditions:

- (1) This device may not cause harmful interference, and (2) this device must accept any interference received, including interference that may cause undesired operation.

NOTE: This equipment has been tested and found to comply with the limits for a Class A digital device, pursuant to part 15 of the FCC Rules. These limits are designed to provide reasonable protection against harmful interference when the equipment is operated in a commercial environment. This equipment generates, uses, and can radiate radio frequency energy, and if it is not installed and used in accordance with the instruction manual, it may cause harmful interference to radio communications. Operation of this equipment in a residential area is likely to cause harmful interference, in which case the user will be required to correct the interference at his own expense.

CAN ICES-3 (A)/NMB-3(A)

EU COMPLIANCE INFORMATION:

Eligible to bear the CE mark; Conforms to European Union Low Voltage Directive 2014/35/EU; European Union EMC Directive 2004/108/EC; European Union Restriction of Hazardous Substances Recast (RoHS2) Directive 2011/65/EU; European Union WEEE (recast) Directive 2012/19/EU; European Union Eco-Design Directive 2009/125/EC; European Union Registration, Evaluation, Authorization and Restriction of Chemicals (REACH) Directive 2006/121/EC

You may obtain a free copy of the Declaration of Conformity by visiting <http://www.amx.com/techcenter/certifications.asp>.

WEEE NOTICE:

	<p>This appliance is labeled in accordance with European Directive 2012/19/EU concerning waste of electrical and electronic equipment (WEEE). This label indicates that this product should not be disposed of with household waste. It should be deposited at an appropriate facility to enable recovery and recycling.</p>
---	--

Table of Contents

Overview	8
Specifications	8
SDX-410-DX/SDX-414-DX	8
SDX-510M-DX/SDX-514M-DX	11
SDX-810-DX	14
Device Connectors	17
Overview	17
Controls and Indicators	18
SELECT Pushbutton	18
LEDs	18
AXLINK KEYPAD Port (4-pin captive-wire)	19
Keypad Feedback.....	19
CONFIG DIP Switch	19
ID Pushbutton.....	20
Dual External Button/LED Control Connectors.....	20
Inputs and Outputs	21
HDMI INPUTS.....	21
GROUP INPUTS (SDX-51xM-DX only)	21
OUTPUTS.....	22
DXLink Connector LEDs.....	22
LAN 10/100	22
PROGRAM Port	22
USB (SDX-51xM-DX only)	23
Power	23
INPUT POWER Connector (SDX-41x-DX and SDX-810-DX only).....	23
AC Power Connector (SDX-51xM-DX only).....	23
Wiring Specifications	24
Overview	24
Port Pinouts and Wiring Specifications.....	24
HDMI INPUTS.....	24
DVI Pinout for DVI-to-HDMI Cable Adapter.....	25
Supported Audio Formats	25
VGA INPUT Ports.....	26
DXLink OUTPUT.....	26
Twisted Pair Cable Pinouts	27
Important Twisted Pair Cabling Requirements and Recommendations.....	27
AXLINK KEYPAD Port	28
Dual External Button/LED Control Connector	29

Installation	30
Overview	30
Mounting the Switcher	30
Surface Mounting	30
Rack Ear Brackets	31
Mounting the Switcher on a Pole	32
Mounting the Switcher on a Rack Shelf	32
Connections and Setup	33
Setting the DIP Switches	33
Enabling the LAN 10/100 Ports on the Switcher	33
Enabling Network Connectivity on the Switcher	33
Connecting the Switcher to a Video Output	33
Applying Power	33
Toggling Between IP Addressing Modes: DHCP and Static IP	33
Assigning a Device Address (ID Mode)	34
Resetting the Factory Default Settings	34
Restore the Factory Firmware Image and Factory Default Parameters	34
Factory Default Parameters	35
Video Switching	36
Overview	36
Auto Switching Mode	36
Manual Switching Mode	36
All Cycle Contact Closure (SDX-51xM-DX only)	36
Group Switching (SDX-51xM-DX only)	36
Upgrading Firmware	37
Overview	37
Solecis Digital Switchers - Firmware Files	37
Before You Start	37
Verifying the Current Firmware Version	37
Downloading the Latest Firmware Files from www.amx.com	37
Upgrading Firmware via NetLinX Studio	38
Programming	40
Overview	40
SEND_COMMANDS	40
Port Functionality Mapping	40
AUDIO SEND_COMMANDS	41
AI<input>O<output>	41
?AUDIN_FORMAT	41
AUDIN_FORMAT	41
?AUDIN_FORMAT_AUTO	41
AUDIN_FORMAT_AUTO	41
?AUDOUT_ASSIGN	41
?AUDOUT_FORMAT	41

AUDOUT_FORMAT.....	41
?AUDOUT_MUTE.....	42
AUDOUT_MUTE.....	42
CI <input>o<output>.....< td=""> <td>42</td> </input>o<output>.....<>	42
Video SEND_COMMANDs	43
?EXTERNAL_BUTTON_ACTION.....	43
EXTERNAL_BUTTON_ACTION.....	43
VI <input>o<output>.....< td=""> <td>43</td> </input>o<output>.....<>	43
?VIDIN_AUTO_SELECT.....	43
VIDIN_AUTO_SELECT.....	43
?VIDIN_EDID.....	43
VIDIN_EDID.....	44
?VIDIN_EDID_AUTO.....	44
VIDIN_EDID_AUTO.....	44
?VIDIN_FORMAT.....	44
?VIDIN_HDCP.....	44
VIDIN_HDCP.....	45
?VIDIN_HSHIFT.....	45
VIDIN_HSHIFT.....	45
?VIDIN_PHASE.....	45
VIDIN_PHASE.....	45
?VIDIN_PREF_EDID.....	45
VIDIN_PREF_EDID.....	46
?VIDIN_RES_REF.....	46
VIDIN_RES_REF.....	46
?VIDIN_STATUS.....	46
?VIDIN_VSHIFT.....	46
VIDIN_VSHIFT.....	46
?VIDOUT_ASSIGN.....	46
?VIDOUT_MUTE.....	47
VIDOUT_MUTE.....	47
?VIDOUT_SLEEP.....	47
VIDOUT_SLEEP.....	47
USB SEND_COMMANDs.....	48
?USB_HID_CONFIG.....	48
USB_HID_CONFIG.....	48
System SEND_COMMANDs.....	48
?FWVERSION.....	48
REBOOT.....	48
Appendix A - Telnet (Terminal) Commands	49
Establishing a Terminal Connection via Telnet.....	49
Establishing a terminal connection via Telnet at the CMD prompt.....	49
Establishing a terminal connection via NetLinx Studio.....	49
Telnet Username and Password	49
Additional Notes.....	49
Setting a Telnet Username and Password.....	50
Telnet Commands	50
? or Help.....	50
DEVICE STATUS.....	50
DIPSWITCH.....	50
EXIT.....	50
FACTORYFWIMAGE.....	50
GET CONFIG.....	51
GET CONNECTION.....	51
GET DEVICE.....	51
GET DNS.....	51
GET FRIENDLY.....	52
GET IP.....	52
GET LOCATION.....	52

GET SN	52
MSG [ON OFF]	52
NDP UNBIND	52
PING [ADDRESS]	52
REBOOT	52
RENEW DHCP	52
RESET FACTORY	52
SEND_COMMAND[D:P:S,"command"]	52
SEND_STRING[D:P:S,"string"]	53
SET CONNECTION	53
SET DEVICE	53
SET DNS	53
SET ETHERNET MODE	53
SET FRIENDLY	54
SET IP	54
SET LOCATION	54
SET TELNET PORT	54
SET TELNET USERNAME	54
SHOW CONNECTION LOG	54
Master Connection Modes	55
Guidelines	55
TCP vs. UDP	55
SHOW CONNECTION STATS	55
SHOW LOG	55
SHOW VS100 STATS	55
URL vs. NDP vs. Auto	56
Notes on Specific Telnet Clients	56
Windows Client Programs	56
Linux Telnet Client	56
Appendix B - Supported Resolutions	57
Available Pixel Display and Refresh Rates	57
DVI, HDMI, and VGA Supported Input Resolutions	57
Appendix C - EDID Programming (SDX-51xM-DX only)	59
DGX Configuration Software Overview	59
PC System Requirements for DGX Configuration Software	59
Software Installation on PC	59
Installing DGX Configuration Software	59
DXLink Connection to PC	59
Using DGX Configuration Software with an SDX-51xM-DX	59
General Notes for Working with DGX Configuration Software and the SDX-51xM-DX	60
EDID Programmer View	61
EDID Overview	61
DXLink Equipment and EDID	61
Reading and Saving EDID Data from a Switcher's HD-15 (VGA) Input Connector	61
Reading and Saving EDID Data from a Switcher	61
Rear Error Message	61
Writing EDID Data to a Switcher's HD-15 (VGA) Input Connector	61
AMX EDID Library	61
Writing VGA EDID Data to a Switcher	62

Overview

Solecis Digital Switchers include the SDX-410-DX 4x1 (FG1010-304), SDX-414-DX 4x1 4K (FG1010-314), and SDX-810-DX 8x1 (FG1010-308) HDMI Digital Switchers and the SDX-510M-DX 5x1 (FG1010-315) and SDX-514M-DX 5x1 4K (FG1010-355) Multi-Format Digital Switchers. The switchers each provide a unique number of user connection points and include simplified local control which routes the selected signal to both a DXLink and HDMI output. The 4K switchers support 4K and Ultra High Definition (UHD) video resolutions for 4K devices.

The SDX-41x-DX provides four user connection points and the SDX-810-DX provides eight. The SDX-51xM-DX provides five user connection points and includes three HDMI and two VGA video inputs.

FIG. 1 displays the Solecis Digital Switchers.

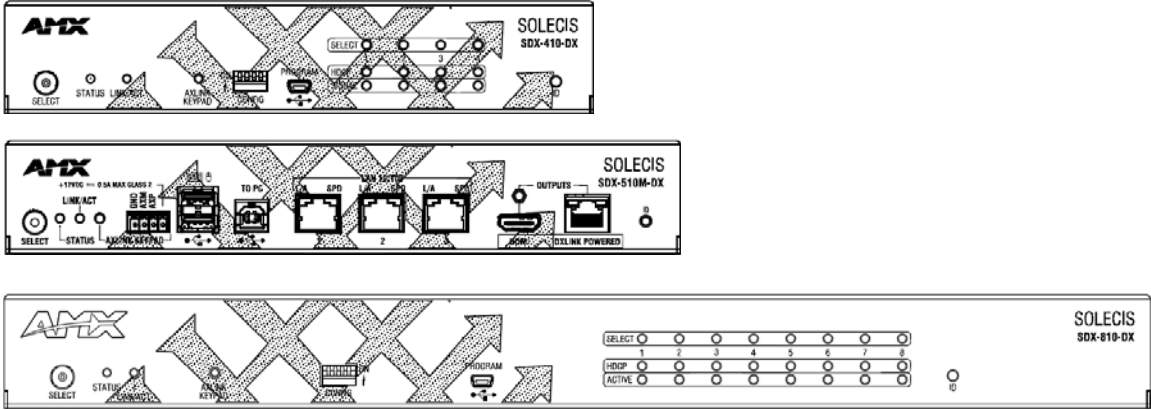

FIG. 1 Solecis Digital Switchers

Specifications

The following sections list the specifications for the Solecis Digital Switchers.

SDX-410-DX/SDX-414-DX

The following table lists the specifications for the SDX-410-DX/SDX-414-DX:

SDX-410-DX/SDX-414-DX Specifications	
General:	
Dimensions (HWD):	1 11/16" x 8 13/16" x 6 7/8" (43.18 mm x 223.52 mm x 175.26 mm)
Weight:	3 lb (1.4 kg)
Mounting Options:	Compatible with all V Style versatile mounting options including rack, surface, or pole
Compatible AMX Enova DVX/DGX and DXLink products:	<ul style="list-style-type: none"> • Enova DGX 8/16/32/64 Digital Media Switchers • Enova DVX-3155HD, DVX-3156HD, and 2155HD All-In-One Presentation Switchers • DXLink HDMI Twisted Pair RX
Included Accessories:	<ul style="list-style-type: none"> • (2) 5-pin Phoenix connectors • (1) 4-pin Phoenix connector • (4) rubber feet • (1) 12 VDC, 5.4A power supply with 3.5mm Phoenix connector with retention screws (FG423-48)
Optional Accessories:	<ul style="list-style-type: none"> • AVB-VSTYLE-SURFACE-MNT, V Style Module Surface Mount (FG1010-722) • NMX-VRK V Style Rack Shelf (FG3201-60) • AVB-VSTYLE-POLE-MNT, V Style Module Pole Mount (FG1010-723) • MET-6N, Metreau 6-Button Keypads with Navigation (FG5794-01-WH/BL) • MET-7, Metreau 7-Button Keypads (FG5794-03-WH/BL) • SP-08-AX-US, 8-Button Keypads (US) with AxLinX (FG1311-08-SW/SB/SA) • SP-08-AX-UK, 8-Button Keypads (UK) with AxLinX (FG1311-08-KW/KB/KA) • SP-08-AX-EU, 8-Button Keypads (EU) with AxLinX (FG1311-08-EW/EB) • HydraPort with HPX-U400-MET-6N, Metreau 6-Button Keypad Kit with Carrier (FG554-11-BL-K) • HydraPort with HPX-U400-MET-7 Metreau 7-Button Keypad Kit with Carrier (FG554-13-BL-K) • HydraPort with HPX-U400-R-MET-6N Metreau 6-Button Keypad Ramp Mount Kit (FG564-11-BL) • HydraPort with HPX-U400-R-MET-7 Metreau 7-Button Keypad Ramp Mount Kit (FG564-13-BL) • CBL-HDMI-FL, HDMI High Speed Flat Cable with RedMere Technology (FG10-2180-16) • CBL-DP-FL, DisplayPort High Speed Flat Cable with RedMere Technology (FG10-2181-16) • CBL-ETH-FL, Ethernet Flat Cable (FG10-2182-16) • CBL-RGB+A-FL, RGB with Audio Flat Cable (FG10-2183-16) • CC-USB, USB Programming Cable (FG10-5965)

SDX-410-DX/SDX-414-DX Specifications (Cont.)	
Signal Transport - DXLink:	
Connector:	(1) RJ-45
Supported Signal Styles:	Digital video, audio, Ethernet, bi-directional control
Transport Layer Throughput (Max):	10.2 Gbps
Twisted Pair Cable Type:	Shielded Cat6, Cat6A and Cat7 DXLink twisted pair cable runs for DXLink equipment shall only be run within a common building where a common building is defined as: the walls of the structure(s) are physically connected and the structure(s) share a single ground reference. For more details and helpful cabling information, reference the white paper titled <i>Cabling for Success with DXLink</i> , or contact your AMX representative.
Twisted Pair Cable Length:	Up to 328 ft. (100 m)
HDCP Support:	Yes
Active Power Requirements:	
Voltage, DC (Typical):	12 VDC
Power Consumption (Max):	18 W
Power Connector:	2-pin 3.5mm Screw Retention Connector
Environmental:	
Temperature (Operating):	32° F to 104° F (0° C to 40° C)
Temperature (Storage):	-22° F to 158° F (-30° C to 70° C)
Humidity (Operating):	5% to 85% non-condensing
Humidity (Storage):	0% to 90% non-condensing
Front Connectors:	
Advanced Configuration Interface:	(1) USB Mini-B Connector
ID Pushbutton:	(1) ID Pushbutton, can be used to assign the unit's Device ID, switch between Static and Dynamic IP addressing modes, and reset the unit to factory defaults.
Back Connectors:	
HDMI Input:	(4) HDMI Type A Female Connectors
HDMI Output:	(1) HDMI Type A Female Connector
DXLink Output:	(1) RJ-45 Connector
LAN 10/100:	(2) RJ-45 Connectors
Local Power:	(1) 2-pin 3.5mm Screw Terminal Connector with Retention Screws
External Button/LED Control Connectors:	(2) 5-pin, 3.5mm Screw Terminal Connectors
AxLink Keypad Control:	(1) 4-pin, 3.5mm Screw Terminal Connector
Ethernet:	
Ethernet Connections:	(2) RJ-45, 10/100 Port provides TCP/IP communication. This is an Auto MDI/MDI-X enabled port, which allows you to use either straight-through or crossover Ethernet cables. The Ethernet Port LEDs show communication activity, connection status, speeds, and mode information.
Ethernet Link/Act Indicator:	(1) Link/Activity LED (green) blinks when receiving Ethernet data packets, one on Ethernet RJ-45 connector and one on the front panel.
Ethernet Speed Indicator:	(1) Speed LED (yellow) lights On when the connection speed is 100 Mbps Ethernet connection and turns OFF when the speed is 10 Mbps
Controls & Indicators:	
AxLink Control Port:	(1), 4-pin 3.5 mm captive-wire connector, provides data and power to up to 2 external AxLink Keypads
AxLink Indicator:	(1) AxLink Keypad LED (green) indicates the state of the AxLink Keypad port

SDX-410-DX/SDX-414-DX Specifications (Cont.)	
Controls & Indicators (Cont.):	
LINK/ACT Indicator:	(1) LED (green), lights when the Ethernet cable is connected and an active link is established. This LED also blinks when receiving Ethernet data packets
Status Indicator:	(1) LED (green), indicates boot and connection status
Power Indicator:	(1) Power LED (green) indicates the unit is powered on
Active Indicator:	(4) Active LEDs (green) indicate that video signal is present
HDCP Indicator:	(4) HDCP LEDs (yellow) indicate that source video is encrypted
Select Indicator:	(4) SELECT LEDs (green) indicate which video input is currently routed to the output
Integrated Switcher:	
Video Switching:	4x1 (dual) audio/video switching, any of 4 inputs can be routed to the HDMI and DXLink output simultaneously
Video Inputs:	(4) HDMI; supports HDMI/HDCP
Video Outputs:	<ul style="list-style-type: none"> • (1) HDMI; supports HDMI/HDCP • (1) DXLink; supports digital video, audio, Ethernet, and bi-directional control
HDCP Support:	Yes
Select Pushbutton:	Press to manually switch the input routed to the output. Each press switches to the next input in order, or if the last input is currently selected, switches to the first input.
HDMI:	
Compatible Formats:	HDMI, HDCP, DVI
Input Signal Type Support:	HDMI DVI-D (Single Link with Cable Adapter) Display Port ++ (Input Only, with HDMI Cable Adapter)
Input Connectors:	(4) HDMI Type A Female
Output Signal Type Support:	HDMI, HDCP, DVI
Input Re-clocking (CDR):	Yes
Deep Color Support:	Yes
Color Space Support:	RGB 4:4:4 YCbCr 4:4:4 and 4:2:2 (Input signal support for YCbCr 4:4:4 and 4:2:2, output color-space is converted to RGB 4:4:4)
3D Format Support:	Yes (HDMI Primary Formats) Frame Packing 1080p up to 24Hz Frame Packing 720p up to 50/60Hz Frame Packing 1080i up to 50/60Hz Top-Bottom 1080p up to 24Hz Top-Bottom 720p up to 50/60Hz Side-by-Side Half 1080p up to 50/60Hz 3D supported when the HDMI DXLink RX Scaler is in Bypass mode and format is 1080p60 or less
Audio Format Support:	Dolby TrueHD, Dolby Digital, DTS-HD Master Audio, DTS, 2 CH through 8 CHL-PCM Dolby Digital and DTS support up to 48kHz, 5.1 channels
Audio Resolution:	16 bit to 24 bit
Audio Sample Rate:	32 kHz, 44.1 kHz, 48 kHz, 96 kHz, 192 kHz
HDCP Support:	Yes Supports AMX HDCP InstaGate Pro Technology When used with an AMX Digital Media Switcher, the key support is up to 16 sinks per output, independent of source device. When used as a single point-to-point solution, the key support is defined by the source device.

SDX-510M-DX/SDX-514M-DX

The following table lists the specifications for the SDX-510M-DX/SDX-514M-DX:

SDX-510M-DX/SDX-514M-DX Specifications	
General:	
Dimensions (HWD):	1 11/16" x 10" x 6 7/8" (43.18 mm x 254 mm x 175.26 mm)
Weight:	3.5 lb (1.6 kg)
Mounting Options:	Compatible with V Style Module Surface Mount or V Style Rack Mount
Compatible AMX Enova DVX/DGX and DXLink products:	<ul style="list-style-type: none"> • Enova DGX 8/16/32/64 Digital Media Switchers • Enova DVX-3155HD, DVX-3156HD, and 2155HD All-In-One Presentation Switchers • DXLink HDMI Twisted Pair RX
Included Accessories:	<ul style="list-style-type: none"> • (2) 5-pin Phoenix connectors • (1) 4-pin Phoenix connector • (1) 3-pin Phoenix connector • (4) rubber feet • (1) universal power cord
Optional Accessories:	<ul style="list-style-type: none"> • AVB-VSTYLE-RMK-1U, V Style Module Tray (FG1010-720) • NMX-VRK V Style Rack Shelf (FG3201-60) • AVB-VSTYLE-POLE-MNT, V Style Module Pole Mount (FG1010-723) • MET-6N, Metreau 6-Button Keypads with Navigation (FG5794-01-WH/BL) • MET-7, Metreau 7-Button Keypads (FG5794-03-WH/BL) • SP-08-AX-US, 8-Button Keypads (US) with AxLinx (FG1311-08-SW/SB/SA) • SP-08-AX-UK, 8-Button Keypads (UK) with AxLinx (FG1311-08-KW/KB/KA) • SP-08-AX-EU, 8-Button Keypads (EU) with AxLinx (FG1311-08-EW/EB) • HydraPort with HPX-U400-MET-6N, Metreau 6-Button Keypad Kit with Carrier (FG554-11-BL-K) • HydraPort with HPX-U400-MET-7 Metreau 7-Button Keypad Kit with Carrier (FG554-13-BL-K) • HydraPort with HPX-U400-R-MET-6N Metreau 6-Button Keypad Ramp Mount Kit (FG564-11-BL) • HydraPort with HPX-U400-R-MET-7 Metreau 7-Button Keypad Ramp Mount Kit (FG564-13-BL) • CBL-HDMI-FL, HDMI High Speed Flat Cable with RedMere Technology (FG10-2180-16) • CBL-DP-FL, DisplayPort High Speed Flat Cable with RedMere Technology (FG10-2181-16) • CBL-ETH-FL, Ethernet Flat Cable (FG10-2182-16) • CBL-RGB+A-FL, RGB with Audio Flat Cable (FG10-2183-16) • CC-USB, USB Programming Cable (FG10-5965)
Signal Transport - DXLink:	
Connector:	(1) RJ-45
Supported Signal Styles:	Digital video, audio, Ethernet, bi-directional control
Transport Layer Throughput (Max):	10.2 Gbps
Twisted Pair Cable Type:	<p>Shielded Cat6, Cat6A and Cat7</p> <p>DXLink twisted pair cable runs for DXLink equipment shall only be run within a common building where a common building is defined as: the walls of the structure(s) are physically connected and the structure(s) share a single ground reference.</p> <p>For more details and helpful cabling information, reference the white paper titled <i>Cabling for Success with DXLink</i>, or contact your AMX representative.</p>
Twisted Pair Cable Length:	Up to 328 ft. (100 m)
HDCP Support:	Yes
Active Power Requirements:	
Voltage, AC (Typical):	110-240VAC, 47-63 Hz
Power Consumption (Max):	48 W
Power Connector:	IEC Power Cord Connector 100-240 VAC 47-63 Hz
DXLink Power:	Supplies power to a DXLink Twisted Pair RX, when used in point-to-point applications
Power Supply:	
Internal, Included	Yes

SDX-510M-DX/SDX-514M-DX Specifications (Cont.)	
Environmental:	
Temperature (Operating):	32° F to 104° F (0° C to 40° C)
Temperature (Storage):	-22° F to 158° F (-30° C to 70° C)
Humidity (Operating):	5% to 85% non-condensing
Humidity (Storage):	0% to 90% non-condensing
USB (HID) Keyboard and Mouse:	
USB (HID)	(1) USB Type Connector ("TO HOST"); connect a Solecis Digital Switcher with DXLink to a PC and emulate keyboard and mouse commands from a DXLink Receiver
Front Connectors:	
ID Pushbutton:	(1) ID Pushbutton, can be used to assign the unit's Device ID, switch between Static and Dynamic IP addressing modes, and reset the unit to factory defaults.
AxLink Keypad Control:	(1) 4-pin, 3.5mm Screw Terminal Connector
LAN 10/100:	(3) RJ-45 Connectors
HDMI Output:	(1) HDMI Type A Female Connector
DXLink Output:	(1) RJ-45 Connector
USB Host Port:	(1) USB Type B Connector "TO HOST"
USB Device Port:	(1) USB Type A Connector, reserved for future use
Back Connectors:	
Advanced Configuration Interface:	(1) USB Mini-B Connector
HDMI Inputs:	(3) HDMI Type A Female Connectors
VGA Inputs:	(2) HD-15 Connectors
Single External Button/LED Control Connector:	(1) 3-pin, 3.5mm Screw Terminal Connector
Dual External Button/LED Control Connector:	(2) 5-pin, 3.5mm Screw Terminal Connectors
Analog Stereo Inputs:	(2) 1/8" mini-Stereo Jack
AC Power Connection:	IEC Power Cord Connector
Ethernet:	
Ethernet Connections:	(3) RJ-45, 10/100 Port provides TCP/IP communication. This is an Auto MDI/MDI-X enabled port, which allows you to use either straight-through or crossover Ethernet cables. The Ethernet Port LEDs show communication activity, connection status, speeds, and mode information.
Ethernet Link/Act Indicator:	(1) Link/Activity LED (green) blinks when receiving Ethernet data packets, one on Ethernet RJ-45 connector and one on the front panel.
Ethernet Speed Indicator:	(1) Speed LED (yellow) lights On when the connection speed is 100 Mbps Ethernet connection and turns OFF when the speed is 10 Mbps
Controls & Indicators:	
AxLink Keypad Port:	(1), 4-pin 3.5 mm captive-wire connector, provides data and power to up to 2 external AxLink Keypads
AxLink Indicator:	(1) AxLink Keypad LED (green) indicates the state of the AxLink Keypad port
LINK/ACT Indicator:	(1) LED (green), lights when the Ethernet cable is connected and an active link is established. This LED also blinks when receiving Ethernet data packets
Status Indicator:	(1) LED (green), indicates boot and connection status
Power Indicator:	(1) Power LED (green) indicates the unit is powered on
ID Pushbutton:	(1) ID Pushbutton, can be used to assign the unit's Device ID, switch between Static and Dynamic IP addressing modes, and reset the unit to factory defaults.
Integrated Switcher:	
Video Switching:	5x1 (dual) audio/video switching, any of 5 inputs can be routed to the HDMI and DXLink output simultaneously
Video Inputs:	<ul style="list-style-type: none"> • (2) HD15; supports RGB • (3) HDMI; supports HDMI/HDCP
Video Outputs:	<ul style="list-style-type: none"> • (1) HDMI; supports HDMI/HDCP • (1) DXLink; supports digital video, audio, Ethernet, and bi-directional control
HDCP Support:	Yes

SDX-510M-DX/SDX-514M-DX Specifications (Cont.)	
HDMI:	
Compatible Formats:	HDMI, HDCP, DVI
Input Signal Type Support:	HDMI DVI-D (Single Link with Cable Adapter) Display Port ++ (Input Only, with HDMI Cable Adapter)
Input Connectors:	(3) HDMI Type A Female
Output Signal Type Support:	HDMI, HDCP, DVI
Input Re-clocking (CDR):	Yes
Deep Color Support:	Yes
Color Space Support:	RGB 4:4:4 YCbCr 4:4:4 and 4:2:2 (Input signal support for YCbCr 4:4:4 and 4:2:2, output color-space is converted to RGB 4:4:4)
3D Format Support:	Yes (HDMI Primary Formats) Frame Packing 1080p up to 24Hz Frame Packing 720p up to 50/60Hz Frame Packing 1080i up to 50/60Hz Top-Bottom 1080p up to 24Hz Top-Bottom 720p up to 50/60Hz Side-by-Side Half 1080p up to 50/60Hz 3D supported when the HDMI DXLink RX Scaler is in Bypass mode and format is 1080p60 or less
Audio Format Support:	Dolby TrueHD, Dolby Digital, DTS-HD Master Audio, DTS, 2 CH through 8 CHL-PCM Dolby Digital and DTS support up to 48kHz, 5.1 channels
Audio Resolution:	16 bit to 24 bit
Audio Sample Rate:	32 kHz, 44.1 kHz, 48 kHz, 96 kHz, 192 kHz
HDCP Support:	Yes Supports AMX HDCP InstaGate Pro Technology When used with an AMX Digital Media Switcher, the key support is up to 16 sinks per output, independent of source device. When used as a single point-to-point solution, the key support is defined by the source device.
Analog Video:	
Compatible Formats:	RGBHV
Input Connector:	HD-15
Resolution Support:	up to 1920x1200@60Hz Reduce Blanking
Auto-Adjust Input:	Supported
Digital Processing:	24-bit, 165 MHz
Stereo Audio:	
Input Signal Types:	Stereo Analog
Input Connectors:	1/8" Mini-Stereo Jack
Analog Input Level (Max):	+2 dBu, unbalanced
Analog to Digital Conversion	48 kHz Sample Rate, 24-bit
Analog to Digital Reference Level	+2.5 dBu = 0 dBfs

SDX-810-DX

The following table lists the specifications for the SDX-810-DX:

SDX-810-DX Specifications	
General:	
Dimensions (HWD):	1 11/16" x 17" x 4 3/8" (43.18 mm x 431.8 mm x 111.25 mm)
Weight:	5.5 lb (2.5 kg)
Compatible AMX Enova DVX/DGX and DXLink products:	<ul style="list-style-type: none"> • Enova DGX 8/16/32/64 Digital Media Switchers • Enova DVX-3155HD, DVX-3156HD, and 2155HD All-In-One Presentation Switchers • DXLink HDMI Twisted Pair RX
Included Accessories:	<ul style="list-style-type: none"> • (2) rack ear brackets • (4) #8-32 x .375 screws • (4) #10-32 x .625 screws • (4) #10 black nylon washers • (4) 5-pin Phoenix connectors • (1) 4-pin Phoenix connector • (4) rubber feet
Optional Accessories:	<ul style="list-style-type: none"> • MET-6N, Metreau 6-Button Keypads with Navigation (FG5794-01-WH/BL) • MET-7, Metreau 7-Button Keypads (FG5794-03-WH/BL) • SP-08-AX-US, 8-Button Keypads (US) with AxLinx (FG1311-08-SW/SB/SA) • SP-08-AX-UK, 8-Button Keypads (UK) with AxLinx (FG1311-08-KW/KB/KA) • SP-08-AX-EU, 8-Button Keypads (EU) with AxLinx (FG1311-08-EW/EB) • HydraPort with HPX-U400-MET-6N, Metreau 6-Button Keypad Kit with Carrier (FG554-11-BL-K) • HydraPort with HPX-U400-MET-7 Metreau 7-Button Keypad Kit with Carrier (FG554-13-BL-K) • HydraPort with HPX-U400-R-MET-6N Metreau 6-Button Keypad Ramp Mount Kit (FG564-11-BL) • HydraPort with HPX-U400-R-MET-7 Metreau 7-Button Keypad Ramp Mount Kit (FG564-13-BL) • CBL-HDMI-FL, HDMI High Speed Flat Cable with RedMere Technology (FG10-2180-16) • CBL-DP-FL, DisplayPort High Speed Flat Cable with RedMere Technology (FG10-2181-16) • CBL-ETH-FL, Ethernet Flat Cable (FG10-2182-16) • CBL-RGB+A-FL, RGB with Audio Flat Cable (FG10-2183-16) • CC-USB, USB Programming Cable (FG10-5965)
Signal Transport - DXLink:	
Connector:	(1) RJ-45
Supported Signal Styles:	Digital video, audio, Ethernet, bi-directional control and power
Transport Layer Throughput (Max):	10.2 Gbps
Twisted Pair Cable Type:	<p>Shielded Cat6, Cat6A and Cat7</p> <p>DXLink twisted pair cable runs for DXLink equipment shall only be run within a common building, where a common building is defined as: the walls of the structure(s) are physically connected and the structure(s) share a single ground reference.</p> <p>For more details and helpful cabling information, reference the white paper titled <i>Cabling for Success with DXLink</i>, or contact your AMX representative.</p>
Active Power Requirements:	
Twisted Pair Cable Length:	Up to 328 ft. (100 m)
HDCP Support:	Yes
Voltage, DC (Typical):	12 VDC
Power Consumption (Max):	21 W
Power Connector:	2-pin 3.5mm Screw Retention Connector
Power Supply:	
External, Required	<p>Optimal performance requires use of one of the following AMX power supplies (not included):</p> <ul style="list-style-type: none"> • PSR4.4, 13.5 VDC, 4.4 A Power Supply with 3.5mm Phoenix Connector with Retention Screws (FG423-46) • PSN6.5, 13.5 VDC, 6.5 A Power Supply with (3) 3.5mm Phoenix Connectors (FG423-41)

SDX-810-DX Specifications (Cont.)	
Environmental:	
Temperature (Operating):	32° F to 104° F (0° C to 40° C)
Temperature (Storage):	-22° F to 158° F (-30° C to 70° C)
Humidity (Operating):	5% to 85% non-condensing
Humidity (Storage):	0% to 90% non-condensing
Front Connectors:	
Advanced Configuration Interface:	(1) USB Mini-B Connector
ID Pushbutton:	(1) ID Pushbutton, can be used to assign the unit's Device ID, switch between Static and Dynamic IP addressing modes, and reset the unit to factory defaults.
Back Connectors:	
HDMI Input:	(8) HDMI Type A Female Connectors
HDMI Output:	(1) HDMI Type A Female Connector
DXLink Output:	(1) RJ-45 Connector
LAN 10/100:	(2) RJ-45 Connectors
Local Power:	(1) 2-pin 3.5mm Screw Terminal Connector with Retention Screws
External Button/LED Control Connectors:	(4) 5-pin, 3.5mm Screw Terminal Connectors
AxLink Keypad Control:	(1) 4-pin, 3.5mm Screw Terminal Connector
Ethernet:	
Ethernet Connections:	(2) RJ-45, 10/100 Port provides TCP/IP communication. This is an Auto MDI/MDI-X enabled port, which allows you to use either straight-through or crossover Ethernet cables. The Ethernet Port LEDs show communication activity, connection status, speeds, and mode information.
Ethernet Link/Act Indicator:	(1) Link/Activity LED (green) blinks when receiving Ethernet data packets, one on Ethernet RJ-45 connector and one on the front panel.
Ethernet Speed Indicator:	(1) Speed LED (yellow) lights On when the connection speed is 100 Mbps Ethernet connection and turns OFF when the speed is 10 Mbps
Controls & Indicators:	
AxLink Control Port:	(1), 4-pin 3.5 mm captive-wire connector, provides data and power to up to 2 external AxLink Keypads
AxLink Indicator:	(1) AxLink Keypad LED (green) indicates the state of the AxLink Keypad port
LINK/ACT Indicator:	(1) LED (green), lights when the Ethernet cable is connected and an active link is established. This LED also blinks when receiving Ethernet data packets
Status Indicator:	(1) LED (green), indicates boot and connection status
Power Indicator:	(1) Power LED (green) indicates the unit is powered on
Signal Indicator:	(8) Signal LEDs (green) indicate that video signal is present
HDCP Indicator:	(8) HDCP LEDs (yellow) indicate that source video is encrypted
Select Indicator:	(8) SELECT LEDs (green) indicate which video input is currently routed to the output
Integrated Switcher:	
Video Switching:	8x1 (dual) audio/video switching, any of 8 inputs can be routed to the HDMI and DXLink output simultaneously
Video Inputs:	(8) HDMI; supports HDMI/HDCP
Video Outputs:	<ul style="list-style-type: none"> • (1) HDMI; supports HDMI/HDCP • (1) DXLink; supports digital video, audio, Ethernet, and bi-directional control
HDCP Support:	Yes
Select Pushbutton:	Press to manually switch the input routed to the output. Each press switches to the next input in order, or if the last input is currently selected, switches to the first input.

SDX-810-DX Specifications (Cont.)	
HDMI:	
Compatible Formats:	HDMI, HDCP, DVI
Input Signal Type Support:	HDMI DVI-D (Single Link with Cable Adapter) Display Port ++ (Input Only, with HDMI Cable Adapter)
Input Connectors:	(8) HDMI Type A Female
Output Signal Type Support:	HDMI, HDCP, DVI
Input Re-clocking (CDR):	Yes
Deep Color Support:	Yes
Color Space Support:	RGB 4:4:4 YCbCr 4:4:4 and 4:2:2 (Input signal support for YCbCr 4:4:4 and 4:2:2, output color-space is converted to RGB 4:4:4)
3D Format Support:	Yes (HDMI Primary Formats) Frame Packing 1080p up to 24Hz Frame Packing 720p up to 50/60Hz Frame Packing 1080i up to 50/60Hz Top-Bottom 1080p up to 24Hz Top-Bottom 720p up to 50/60Hz Side-by-Side Half 1080p up to 50/60Hz 3D supported when the HDMI DXLink RX Scaler is in Bypass mode and format is 1080p60 or less
Audio Format Support:	Dolby TrueHD, Dolby Digital, DTS-HD Master Audio, DTS, 2 CH through 8 CHL-PCM Dolby Digital and DTS support up to 48kHz, 5.1 channels
Audio Resolution:	16 bit to 24 bit
Audio Sample Rate:	32 kHz, 44.1 kHz, 48 kHz, 96 kHz, 192 kHz
HDCP Support:	Yes Supports AMX HDCP InstaGate Pro Technology When used with an AMX Digital Media Switcher, the key support is up to 16 sinks per output, independent of source device. When used as a single point-to-point solution, the key support is defined by the source device.

Device Connectors

Overview

This chapter provides functional details for each item on the front and rear panel of the Solecis Digital Switchers. See the *Wiring Specifications* section on page 24 for information on wiring connectors for individual ports.

FIG. 2 displays the front panels of the SDX-410-DX, SDX-510M-DX, and SDX-810-DX:

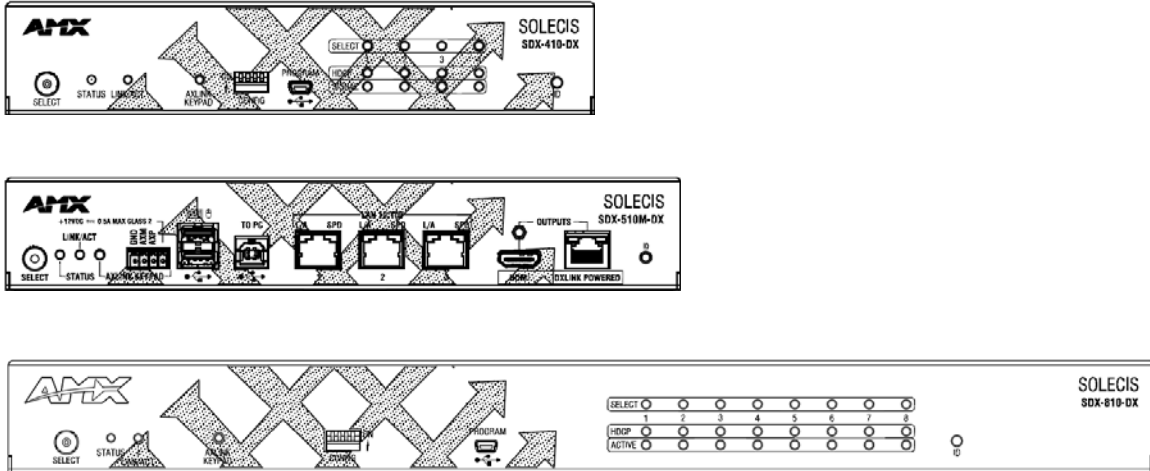

FIG. 2 Solecis Digital Switchers front panels

FIG. 3 displays the back panel of the SDX-410-DX, SDX-510M-DX, and SDX-810-DX:

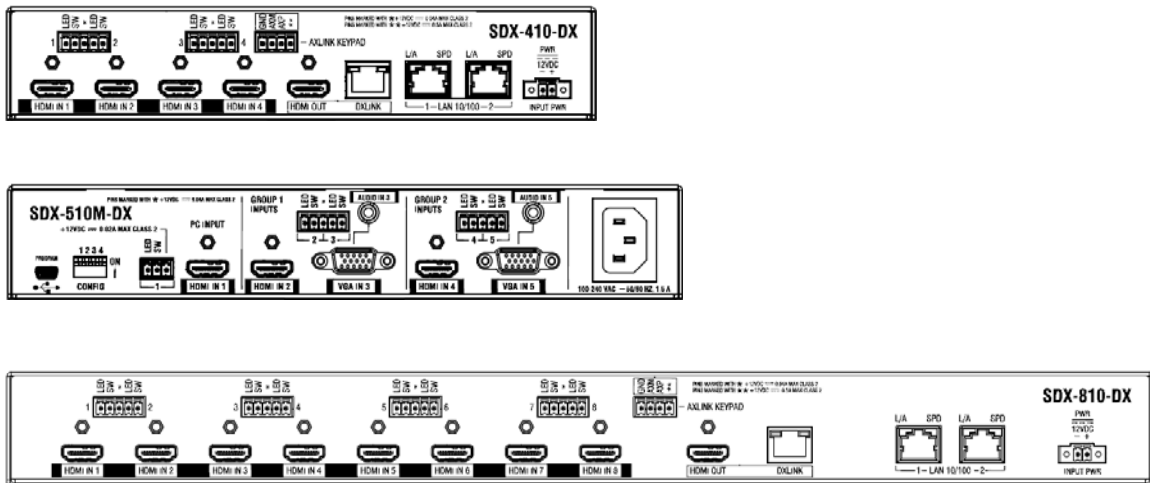

FIG. 3 Solecis Digital Switchers back panels

Controls and Indicators

The following sub-sections describe each component on the front panel of the switcher. Refer to FIG. 2 on page 17 for the component layout of the front panel.

SELECT Pushbutton

Press the SELECT pushbutton to manually switch the input routed to the output. Each press switches to the next input in order, or if the last input is currently selected, switches to the first input. The pushbutton features a POWER LED, which indicates the switcher is powered on.

FIG. 4 displays the SELECT pushbutton.



FIG. 4 SELECT Pushbutton

LEDs

The LEDs on the front panel indicate the communications status of several different connections. All Solecis Digital Switchers feature STATUS, LINK/ACT, and AXLINK KEYPAD LEDs. The SDX-41x-DX and SDX-810-DX also feature SELECT, HDCP, and ACTIVE LEDs for each available input on the switchers.

FIG. 5 displays the front panel LEDs on the SDX-410-DX.

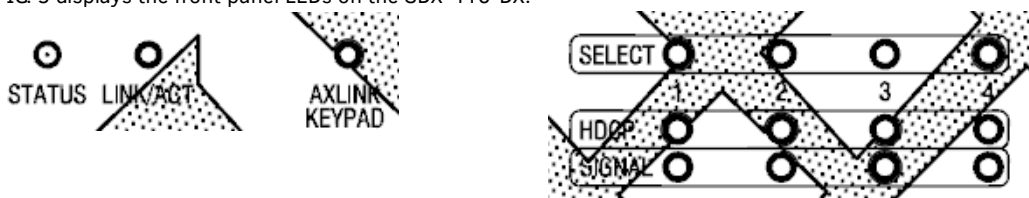

FIG. 5 Front Panel - LEDs (SDX-410-DX)

The following table provides the details for each LED on the switchers:

Front Panel LEDs		
Label	Color	Description
STATUS	green	Indicates the boot and connection status.
LINK/ACT	green	Indicates communication status. This LED also blinks when receiving data.
AXLINK KEYPAD	green	Blinks to indicate the status of the AxLink Keypad port (located on the rear panel of the device.) <ul style="list-style-type: none"> • Off - No power, or the switcher is not functioning properly. • 1 blink per second - Normal operation. • 3 blinks per second - AxLink bus error. Check all AxLink bus connections.
The following LEDs are only available on the SDX-41x-DX and SDX-810-DX:		
SELECT	green	Indicates which video input is currently routed to the video output.
HDCP	yellow	Indicates that the source video is encrypted. <p>NOTE: If the selected input has the HDCP disabled, all HDCP LEDs will be off. If selected input has HDCP enabled, the inputs with protected content will have HDCP LEDs on. See the VIDIN_HDCP section on page 45 for information about enabling and disabling HDCP.</p>
ACTIVE	green	Indicates that a video signal is present.

AXLINK KEYPAD Port (4-pin captive-wire)

The AXLINK KEYPAD port allows the switcher to provide power and data to up to two AMX AxLink Keypads. AxLink functionality requires a NetLink Master to be present on the connected network. The AXLINK KEYPAD LED, indicating activity on the port, is located on the front panel of the device. See the *LEDs* section on page 18 for more information.

FIG. 6 displays the AxLink ports on the SDX-41x-DX and SDX-51xM-DX.

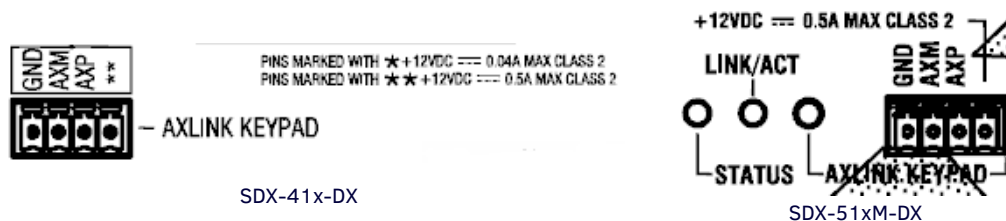

FIG. 6 AxLink Ports

The AxLink port can be used to supply power to downstream AxLink-compatible devices. The port is capable of providing at least 0.5 Amps of 12V power.

For information on wiring for the AxLink port, see the *AXLINK KEYPAD Port* section on page 28.

Keypad Feedback

You can provide feedback such as button illumination on a keypad button press by turning ON the button channel of the defined AxLink keypad when a button is pressed. Setting the button channel to OFF turns off the button keypad LED.

NOTE: You cannot change the button LED brightness when the keypad is connected to the switcher. You can only change the LED brightness when the keypad is connected to a Master. You can connect the keypad to a Master, set the LED brightness, then connect the keypad to the switcher and the button LEDs will retain their brightness settings from the Master. Consult the Instruction Manual for your keypad for information on setting the button LED brightness.

CONFIG DIP Switch

Use the Configuration DIP switch to enable/disable the LAN ports, set the DXLink mode, and set network connectivity. All DIP switches are initially set to the OFF position. DIP switch settings are read on reboot. Any changes to the DIP switch settings are not acted upon until after you reboot the device.

FIG. 7 displays the CONFIG DIP switch.

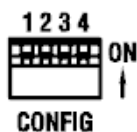

FIG. 7 CONFIG DIP switch

The DIP switches are numbered 1-4 from left to right. The following table lists the settings for each DIP switch.

DIP Switch Settings			
Pin	Description	ON	OFF
1	Enable/Disable LAN 10/100	Enables all External LAN 10/100 ports	Disables all External LAN 10/100 ports
2	Set the DXLink mode	Maintains ability to read the DIP switch but takes no action. Always responds to the ?DXLINK command as an endpoint.	
3	Network Connectivity	IP for the internal processor is enabled. This switch does not affect the External Ethernet ports.	IP for the internal processor is disabled. This switch does not affect the External Ethernet ports.
4	Set the external button behavior of the SDX-51xM-DX to Cycle or Direct*. You must reboot the switcher to enable any change in the switch setting. (This switch does not effect the SDX-410/414-DX or SDX-810-DX.)	Sets the external button behavior to Direct during a reboot. Setting this switch to the ON position without rebooting the switcher does not change the external button behavior.	Uses the external button behavior setting established by the EXTERNAL_BUTTON_ACTION command. NOTE: To upload a custom VGA EDID using DGX Configuration Software, switch 4 must be set to OFF.

* - In Cycle mode, an external button press results in a move to the next video input (see the *All Cycle Contact Closure (SDX-51xM-DX only)* section on page 36 for more information.) In Direct mode, the external buttons directly relate to the input (external button 1 selects input 1, external button 2 selects button 2, etc.)

ID Pushbutton

The ID Pushbutton can be used to perform four types of initial configuration settings:

- Toggle between DHCP and static IP addressing (see page 33)
- Assign a device address (see page 34)
- Reset the unit to its factory default settings, which affects the parameters but not the firmware version (see page 34)
- Restore the unit to its factory firmware image, which affects both the firmware version and the parameters (see page 34)

The functions performed depend on when and for how long the ID Pushbutton is pressed and held. ID Pushbutton functions can also be implemented using Telnet commands.

FIG. 8 displays the ID pushbutton.



FIG. 8 ID Pushbutton

Dual External Button/LED Control Connectors

The Dual External Button/LED Control connectors are 5-pin, 3.5mm terminal screw connectors that you can use to connect a single-button module such as the HPX-U100-BTN.

Each 5-pin connector accepts up to two single-button modules. The SDX-41x-DX features two 5-pin connectors, so you can connect up to four single-button modules to the switcher. The SDX-810-DX features four 5-pin connectors, allowing for up to eight single-button module connections to the switcher. (The SDX-51xM-DX features one 3-pin External button connector and two sets of 5-pin Dual External button connectors. See the *GROUP INPUTS (SDX-51xM-DX only)* section on page 21 for more information on how the 3-pin External button connector works with group inputs.)

With a single button module connected to one of these Dual External Button connectors, you can press the button on the module to switch to the corresponding input, and also send a button press event to a connected Master. You can use this function to have the Master send a command back to the switcher to execute an additional event.

FIG. 9 displays the Dual External Button/LED Control Connectors on the SDX-41x-DX.



FIG. 9 Dual External Button/LED Control connectors (SDX-41x-DX)

FIG. 10 displays the External Button/LED Control Connector on the SDX-510M-DX.

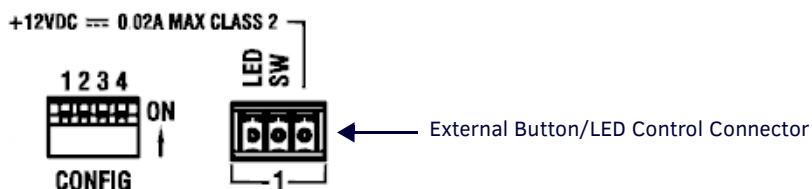

FIG. 10 External Button/LED Control Connector (SDX-510M-DX)

For wiring information for these connectors, see the *Dual External Button/LED Control Connector* section on page 29.

Inputs and Outputs

The following sub-sections describe each component on the rear panel of the switchers. Refer to FIG. 3 on page 17 for the complete layout of the rear panel.

HDMI INPUTS

The HDMI INPUT connectors on the rear panel route digital video (and audio) from connected source input devices to the connected output devices. The SDX-41x-DX features four connectors, while the SDX-810-DX features eight and the SDX-51xM-DX features three. These inputs support the following audio formats:

- Dolby TrueHD
- Dolby Digital
- DTS-HD Master Audio™
- DTS

NOTE: 2 CH through 8 CH L-PCM Dolby Digital and DTS support up to 48kHz, 5.1 channels.

FIG. 11 displays the HDMI INPUTS for the SDX-41x-DX.



FIG. 11 HDMI INPUTS

For more information about these connectors, including wiring, see the *HDMI INPUTS* section on page 24.

GROUP INPUTS (SDX-51xM-DX only)

The two GROUP INPUTS areas on the rear panel each feature an HDMI port, a 15-pin VGA port, a 1/8" mini-Stereo jack, and a 5-pin 3.5mm Dual External Button/LED Control connector.

The HDMI input supports a digital audio/video source. The VGA input port supports analog video. Use the 1/8" mini-Stereo jack for analog audio. Though these two sets of input ports support separate digital and analog video sources, you can only select one input at a time to be sourced to the output ports.

The SDX-51xM-DX has two sets of groups in which the first group external button/LED control connector is used to cycle through the inputs within a particular group. On the SDX-51xM-DX, HDMI INPUT 1 is always the first input on both groups. Group 1 contains inputs 1, 2, and 3. Group 2 contains inputs 1, 4, and 5. You can route the audio/video from one input within a group at a time.

You can cycle through the inputs in each group by clicking a single button module connected to the Dual External button/LED Control connector for each group (see FIG. 12). For group 1, connect the single button module to contact closure 2. For group 2, connect the single button module to contact closure 4. Connecting button modules to contact closures 3 or 5 will not have any effect on switching within either group. Contact closures 3 and 5 are not tied to specific inputs, but you can use them for an auxiliary button press trigger event notification which can be recognized by a NetLinX Master for programming purposes.

NOTE: If there is only signal on the PC-IN HDMI port and no signal on the Group HDMI or VGA ports, then an external button press on the specified Group will toggle between the PC-IN HDMI and Black Video with Analog Audio.

NOTE: With Group Input button switching, connection to a Master is not needed. The button press results in the switcher directly cycling through the inputs in the group.

FIG. 12 displays the GROUP INPUTS area.

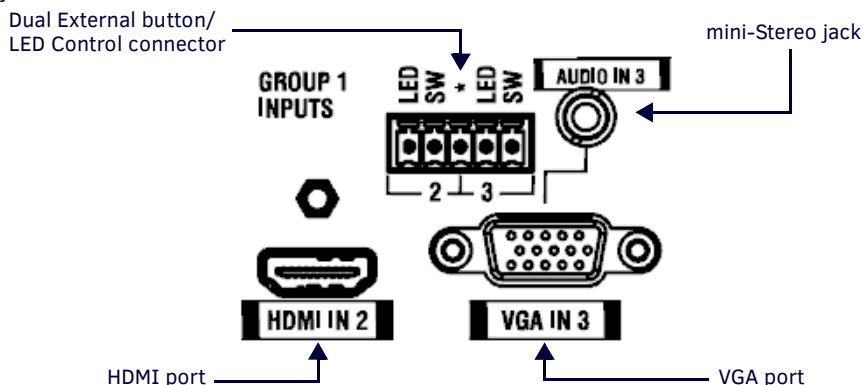

FIG. 12 GROUP INPUTS area

OUTPUTS

One HDMI connector and one DXLink (RJ-45) port transport digital video, embedded audio, Ethernet, and bi-directional control over twisted pair cable to DXLink devices or boards, including digitally transcoded analog video signals. Both inputs support HDCP. The output resolution follows the selected source input's resolution.

FIG. 13 displays the HDMI and DXLink output ports.

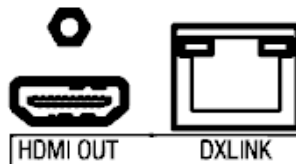

FIG. 13 Output ports

See the *Important Twisted Pair Cabling Requirements and Recommendations* section on page 27 for information about cable requirements for the DXLink port.

DXLink Connector LEDs

This section applies to the LEDs located on the DXLink (RJ-45) port.

Yellow LED:

- On — Authenticated HDCP (handshaking has occurred successfully)
- Flashing — Video active; no HDCP
- Off — No Video

Green LED:

- On — DXLink connection established (in Endpoint Mode between TX or RX and switcher)
- Off — DXLink connection not established

LAN 10/100

The LAN 10/100 RJ-45 ports provide 10/100 Mbps TCP/IP communication. These are Auto MDI/MDI-X enabled ports, which allow you to use either straight-through or crossover Ethernet cables. The port LEDs show communication activity, connection status, speeds, and mode information. The SDX-41x-DX and SDX-810-DX each feature two LAN 10/100 ports located on the back panel of the units. The SDX-51xM-DX features three LAN 10/100 ports located on its front panel.

FIG. 14 displays the LAN 10/100 ports.

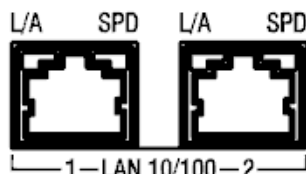

FIG. 14 LAN 10/100 ports

FIG. 15 describes the blink activity for the LAN 10/100 port and cable.

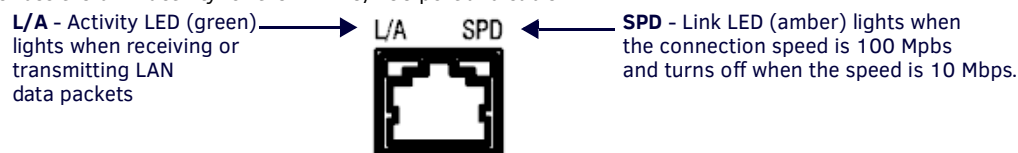

FIG. 15 LAN connector / LEDs

PROGRAM Port

The PROGRAM port is a USB mini-B connector that connects the switcher to a communication port on a PC, and supports the DGX Configuration Software for programming a custom VGA EDID.

FIG. 16 displays the PROGRAM port.



FIG. 16 PROGRAM port

USB (SDX-51xM-DX only)

The two type-A USB connectors on the front panel are used to connect peripheral devices to the SDX-51xM-DX (FIG. 17). You can use the type-B USB connector to connect the switcher to a PC and emulate keyboard and mouse commands from a DXLink Receiver.

NOTE: *The Type-A USB connectors are reserved for future use.*

FIG. 17 displays the USB ports.

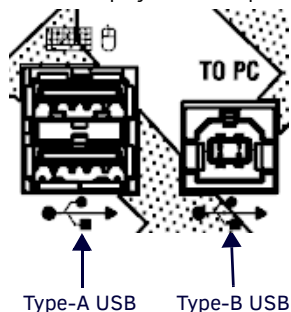

FIG. 17 USB ports

Power

This section describes the power options for the Solecis Digital Switchers.

NOTE: *Apply power to the unit only after installation is complete.*

INPUT PWR Connector (SDX-41x-DX and SDX-810-DX only)

The INPUT PWR connector is a 2-pin 3.5mm screw terminal connector with retention screws. This power connector is available on the SDX-41x-DX and SDX-810-DX.

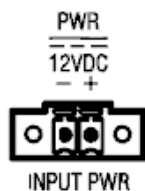

FIG. 18 INPUT PWR connector

The SDX-41x-DX ships with a 12 VDC, 5.4A power supply (**FG423-48**).

Optimal performance for the SDX-810-DX requires use of one of the following AMX power supplies (not included):

- PSR4.4, 13.5 VDC, 4.4 A Power Supply with 3.5mm Phoenix Connector with Retention Screws (**FG423-46**)
- PSN6.5, 13.5 VDC, 6.5 A Power Supply with (3) 3.5mm Phoenix Connectors (**FG423-41**)

AC Power Connector (SDX-51xM-DX only)

The SDX-51xM-DX receives power through a ~100-240V, 50/60 Hz connector. FIG. 19 displays the power connector for the SDX-51xM-DX.

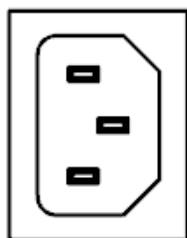

100-240 VAC ~50/60 HZ, 1.5 A

FIG. 19 Power Connector

Wiring Specifications

Overview

This chapter provides the port pinouts and wiring specifications (when applicable) for each port on the front and rear panels of the Solecis Digital Switchers.

Port Pinouts and Wiring Specifications

The following sub-sections describe the wiring for each port on the SDX switchers. Refer to the *Device Connectors* section on page 17 for the component layout of the switchers.

HDMI INPUTS

The HDMI INPUT connectors on Solecis Digital Switchers are used to connect source input devices to the device. The switcher routes digital video and audio from connected source input devices to the connected output devices. These ports support HDMI (with 3D and Deep Color) and HDCP.

The following table describes the pinout configuration of the HDMI INPUTS connectors:

HDMI INPUT Connectors - Pinouts and Signals			
Pin	Signal	Pin	Signal
1	TMDS Data 2+	11	TMDS Clock Shield
2	TMDS Data 2 Shield	12	TMDS Clock-
3	TMDS Data 2-	13	CEC
4	TMDS Data 1+	14	Reserved, HEC Data
5	TMDS Data 1 Shield	15	SCL
6	TMDS Data 1-	16	SDA
7	TMDS Data 0+	17	DDC/CEC/HEC Ground
8	TMDS Data 0 Shield	18	+5V Power (max 50mA)
9	TMDS Data 0-	19	Hot Plug Detect, HEC Data+
10	TMDS Clock+		

FIG. 20 displays the pin locations for the HDMI INPUTS:

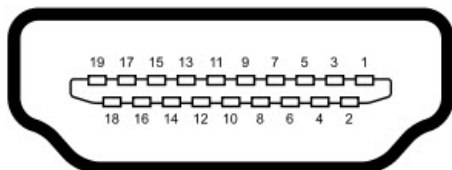

FIG. 20 HDMI pinouts

To connect HDMI input source devices (DVI and HDMI) to the HDMI INPUT connectors, the following (optional) adapter cables are required:

DVI Input Adapter Cables			
Name	Description	Length	FG#
HDMI Interface Cable	HDMI Male to HDMI Male	6 1/2' (2m)	FG10-2178-05
HDMI to DVI Cable	HDMI Male to DVI Male (See the <i>DVI Pinout for DVI-to-HDMI Cable Adapter</i> section on page 25 for more information on DVI-to-HDMI cable wiring.)	6' (1.828m)	FG10-2179

DVI Pinout for DVI-to-HDMI Cable Adapter

The pinout in FIG. 21 is for DVI-to-HDMI cable adapters which can be used with the modules when a DVI-I signal is required.



FIG. 21 DVI pinout for DVI-to-HDMI cable adapter

DVI Connector Pinout			
DVI Input Pin #	Signal Name	DVI Output Pin #	Signal Name
1	Data 2-	1	Data 2-
2	Data 2+	2	Data 2+
3	GND	3	GND
4	n/c	4	n/c
5	n/c	5	n/c
6	DDC-CLK	6	DDC-CLK
7	DDC-Data	7	DDC-Data
8	n/c	8	n/c
9	Data 1-	9	Data 1-
10	Data 1+	10	Data 1+
11	GND	11	GND
12	n/c	12	n/c
13	n/c	13	n/c
14	+5 VDC In	14	+5 VDC Out*
15	GND	15	GND
16	Hot-Detect	16	Hot-Detect
17	Data 0-	17	Data 0-
18	Data 0+	18	Data 0+
19	GND	19	GND
20	n/c	20	n/c
21	n/c	21	n/c
22	GND	22	GND
23	CLK+	23	CLK+
24	CLK-	24	CLK-
C1	n/c	C1	n/c
C2	n/c	C2	n/c
C3	n/c	C3	n/c
C4	n/c	C4	n/c
C5	n/c	C5	n/c

*The +5 VDC on output pin 14 supplies a maximum of 55 mA.

Supported Audio Formats

The HDMI INPUT connectors on the rear panel route digital audio (and video) from connected source input devices to the connected output devices. These inputs support the following audio formats:

- Dolby TrueHD
- Dolby Digital
- DTS-HD Master Audio™
- DTS

VGA INPUT Ports

The SDX-51xM-DX features two VGA input ports on the rear panel to route analog video from connected source input devices to the connected output devices. These ports support standard VGA cabling.

FIG. 22 displays one of the VGA inputs.



FIG. 22 VGA INPUT 3

The VGA inputs are used to accept RGBHV video from a source device. The following table provides cable pinout details for HD-15 connections for RGBHV.

VGA Input Port Cable Pinouts	
Input Pin #	VGA-RGBHV
1	Red
2	Green
3	Blue
4	n/c
5	GND
6	GND - Red
7	GND - Green
8	GND - Blue
9	+5 V DDC
10	GND
11	n/c
12	DDC_SDA
13	H Sync
14	V Sync
15	DDC_SCL

FIG. 23 displays the pinouts for the VGA inputs.

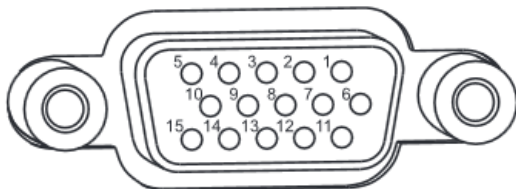

FIG. 23 VGA Input Pins

DXLink OUTPUT

One DXLink (RJ-45) connector transports digital video, embedded audio, Ethernet, and bi-directional control over twisted pair cable to DXLink devices or boards, including digitally transcoded analog video signals. The DXLink output supports HDCP.

NOTE: The DXLink output on the SDX-51xM-DX provides Power Over DXLink to compatible DXLink Receivers so they do not need local power at the display or projector.

FIG. 24 displays the DXLink output.



FIG. 24 DXLINK OUTPUT

See the *Important Twisted Pair Cabling Requirements and Recommendations* section on page 27 for information about cable requirements for these ports.

Twisted Pair Cable Pinouts

AMX supports both the T568A and T568B pinout specifications for termination of the twisted pair cable used between the switcher and the DXLink receiver.

FIG. 25 displays the twisted pair pinout specifications for the DXLink input.

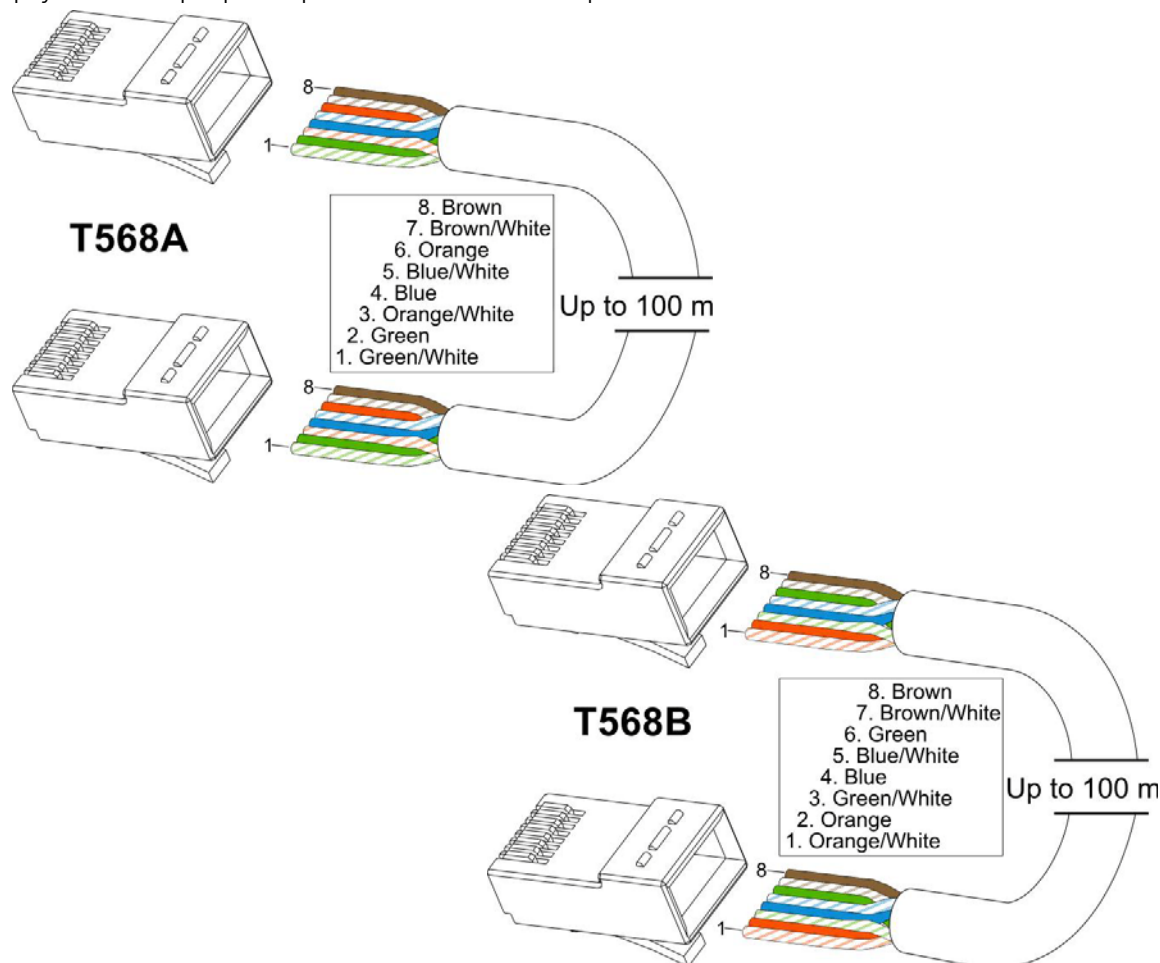

FIG. 25 Twisted pair cable pinouts for T568A (recommended) and T568B specifications

Important Twisted Pair Cabling Requirements and Recommendations

The following requirements and recommendations apply to cabling DXLink (RJ-45) connectors:

- DXLink cable runs require shielded category cable (STP) of Cat6 (or better).
- DXLink twisted pair cable runs for DXLink equipment shall only be run within a common building.*
- DXLink delivers 10.2 Gb/s throughput over shielded category cable. Based on this bandwidth requirement, we recommend following industry standard practices designed for 10 Gigabit Ethernet when designing and installing the cable infrastructure.
- The cables should not be longer than necessary to reach the end-points. We recommend terminating the cable to the actual distance required rather than leaving any excess cable in a service loop.

For more details and helpful cabling information, reference the white paper titled "Cabling for Success with DXLink" available at www.amx.com or contact your AMX representative.

* "Common building" is defined as: Where the walls of the structure(s) are physically connected and the structure(s) share a single ground reference.

AXLINK KEYPAD Port

The AXLINK KEYPAD port allows the switcher to provide data and power to up to two external AxLink keypads. FIG. 26 displays the AxLink port on the SDX-41x-DX.

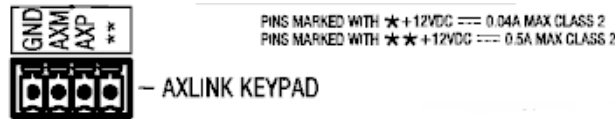

FIG. 26 AXLINK KEYPAD Port (SDX-41x-DX)

The green AXLINK KEYPAD LED indicates AxLink data activity:

- **Off** - No power, or the switcher is not functioning properly.
- **1 blink per second** - Normal operation.
- **3 blinks per second** - AxLink bus error. Check all AxLink bus connections.

NOTE: The AXLINK KEYPAD LED is located on the front panel of the SDX-41x-DX and SDX-810-DX while the AxLink port itself is located on the rear panel. On the SDX-51xM-DX, both the port and LED are located beside each other on the front panel.

The AxLink port can be used to supply power to AxLink keypads. The port is capable of providing at least 2 Amps of 12V power up to a maximum distance of 175ft. (53.34m).

FIG. 27 provides wiring requirements for the AxLink connector:



FIG. 27 Mini-Phoenix connector wiring diagram (direct data and power)

To use the 4-pin 3.5 mm mini-Phoenix (female) captive-wire connector for data communication and power transfer, the incoming PWR and GND cable from the 12 VDC-compliant power supply must be connected to the AxLink cable connector going to the switcher.

FIG. 28 shows the wiring diagram.

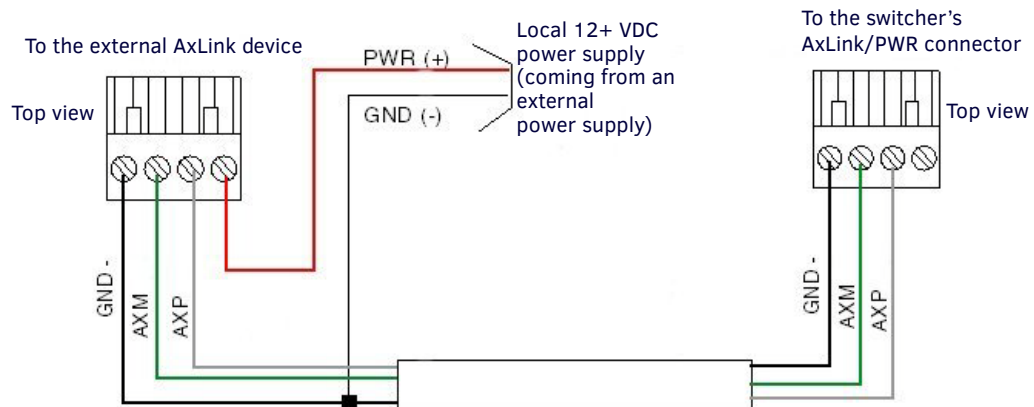

FIG. 28 4-pin mini-Phoenix connector wiring diagram (using external power source)

CAUTION: When you connect an external power supply, do not connect the wire from the PWR terminal (coming from the external device) to the PWR terminal on the Phoenix connector attached to the switcher unit. Make sure to connect only the AXM, AXP, and GND wires to the switcher's Phoenix connector when using an external power supply.

Make sure to connect only the GND wire on the AxLink/PWR connector when using a separate 12 VDC power supply. Do not connect the PWR wire to the AxLink connector's PWR (+) opening.

Dual External Button/LED Control Connector

When connecting switcher to an HPX-U100-BTN button the wiring is as follows:

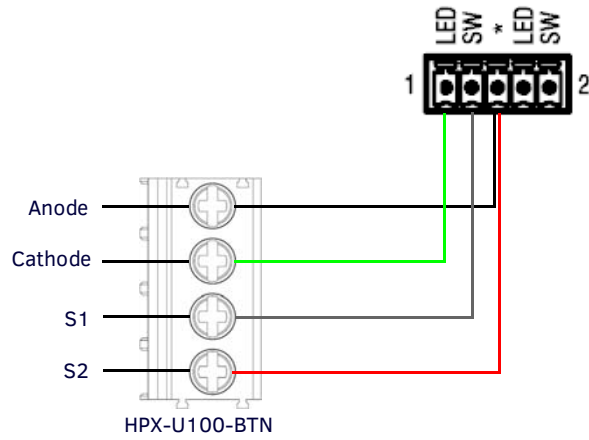

FIG. 29 External button/LED Control connector wiring

Installation

Overview

Installing the Solecis Digital Switcher is a quick and simple process. Before connecting the switcher to its peripheral devices and powering the device, be sure to mount the device using one of the methods detailed below. The switchers also include rubber feet that you can apply to the bottom of the device for table-top mounting.

Also included in this chapter is information on making initial connections and configurations to begin running your switcher.

Mounting the Switcher

The Solecis Digital Switchers can be mounted using V Style Surface Mounting Brackets. The Surface Mount Brackets are designed for mounting a single module (to a wall, on or under a desk, etc.) The brackets may be attached to mount the top or the bottom flush with the mounting surface. They are optionally available for the SDX-41x-DX and the SDX-51xM-DX.

Insert the #4-40 3/16 inch pan head screws (provided) as shown in FIG. 30 and tighten. Brackets can either align flush with the top or with the bottom.

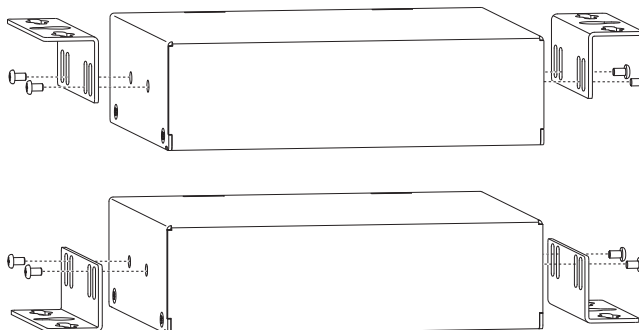

FIG. 30 Installing Surface Mount Brackets

Surface Mounting

Perform the following steps to surface mount the switcher:

NOTE: The #8 x 1/2 inch tapping pan head screws provided for mounting to a flat surface are designed for wood. If the module needs to be mounted on a different type of surface, use the appropriate type of fastener, e.g., dry wall anchors (not provided).

1. Place the switcher in the desired final position on the mounting surface and mark the screw position as indicated in FIG. 31.

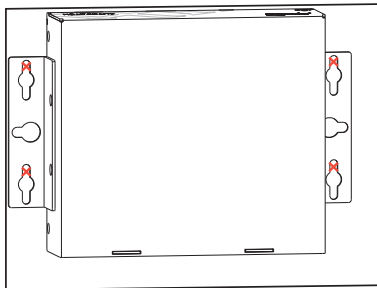

FIG. 31 Mark screw positions

IMPORTANT: The mark for the screw's position in each of the mounting holes needs to be made in the end of the slots (all marks to either the top of the slots or all marks to the bottom).

2. Set the device aside. If using the wood screws provided, drill pilot holes (drill size 29; hole diameter 0.136 in.) for the screws 1/2 inch (1.27 cm) deep. Insert the screws in the holes, but do not tighten them completely.

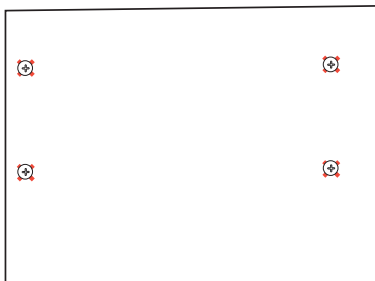

FIG. 32 Pilot holes with screws

3. Align the module with the center of the double key-hole slots over the screws and slide into place as indicated in FIG. 33.

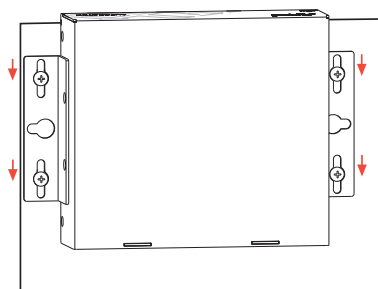

FIG. 33 Sliding the switcher onto the Wall Mount Screws

4. Tighten the screws.

Rack Ear Brackets

Rack ear brackets are included with the SDX-810-DX. The rack ear brackets are designed for mounting a single module (to a wall, on or under a desk, etc.) You can rotate the included brackets 90° in any direction to accommodate several different mounting options, including rack, tabletop, under/over the table, and vertical wall mounting.

Position and install the mounting brackets, as shown in FIG. 34, using the supplied mounting screws.

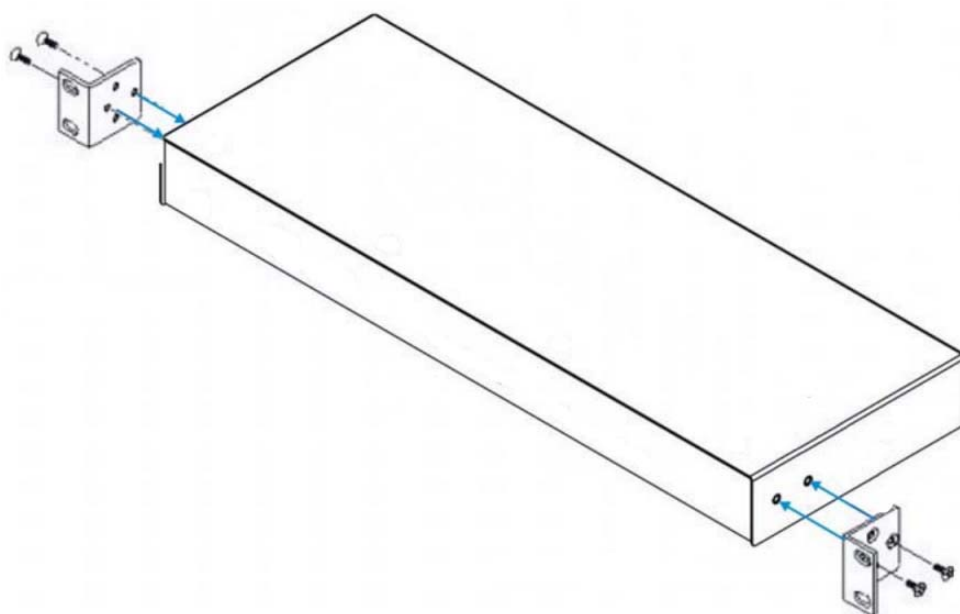

FIG. 34 Mounting the rack ears on the SDX-810-DX

Mounting the Switcher on a Pole

The AVB-VSTYLE-POLE-MNT, V Style Single Module Pole Mounting Kit (**FG1010-723**) is designed for mounting a single module to a projector pipe (or other 2 inch diameter pipes). The kit contains all the mounting hardware for the assembly in FIG. 35.

Perform these steps to mount the switcher on a pole:

1. Attach the mounting brackets to the module according to the instructions for surface mounting (see FIG. 30).
2. Insert the first u-bolt around the pole/pipe and through the bracket and plate according to FIG. 35.
3. Fasten securely with the hex nuts.
4. Repeat Steps 2 and 3 using the remaining u-bolt, bracket, plate, and hex nuts.

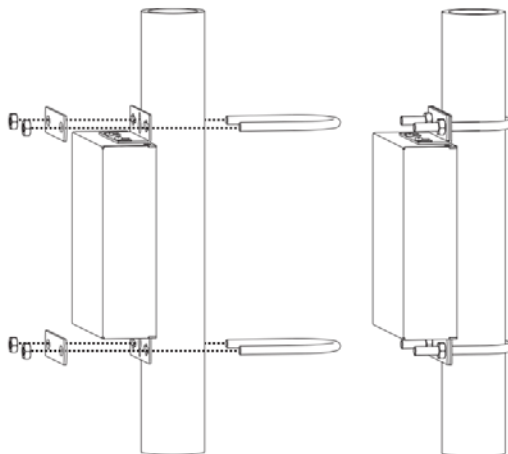

FIG. 35 Mount to projector pipe with bolts through brackets

Mounting the Switcher on a Rack Shelf

You can mount the SDX-41x-DX and SDX-51xM-DX switchers on a rack shelf by using an NMX-VRK V-Style Rack Shelf (**FG3201-60**). In addition to the switcher, you can also use wire ties to mount the switcher's power supply on the rack shelf.

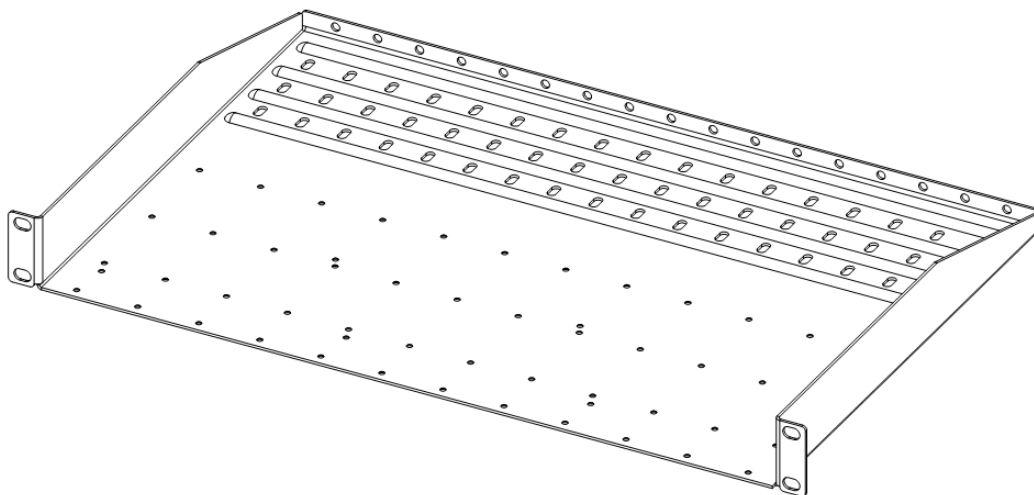

FIG. 36 NMX-VRK V-Style Rack Shelf

Perform these steps to mount the switcher using the NMX-VRK Rack Shelf:

1. Invert the switcher and the rack shelf for ease of installation.
2. Attach the rack shelf to the bottom of the switcher using the #4-40 3/16 inch undercut flat head screws (provided). Insert the screws through the underside of the rack shelf and into the holes on the bottom of the switcher. Note that only two screws are required.
3. Install the rack shelf in a standard EIA 19 in. (48.26 cm) rack and secure with rack-mounting screws.
4. (This step is optional.) Attach fill plates using the #4-40 3/16 inch undercut flat head screws (provided). Be sure to use the screw holes closest to the front of the tray.
5. Use wire ties (not provided) to mount the power supply to the rear section of the rack shelf. This step is optional.

Connections and Setup

The following sections describe how to connect your switcher to your network, audio/video sources, and accessories.

Setting the DIP Switches

Use the Configuration DIP switch to enable/disable the LAN ports and set network connectivity. All DIP switches are initially set to the OFF position. The DIP switches are located on the front panels of the SDX-41x-DX and SDX-810-DX, and on the rear panel of the SDX-51xM-DX.

Enabling the LAN 10/100 Ports on the Switcher

The LAN 10/100 ports on the switchers are disabled by default. You can enable the ports by setting #1 DIP switch to ON (see FIG. 37).

Enabling Network Connectivity on the Switcher

Network connectivity on the switchers is disabled by default. You can enable network connectivity by setting #3 DIP switch to ON (see FIG. 37).

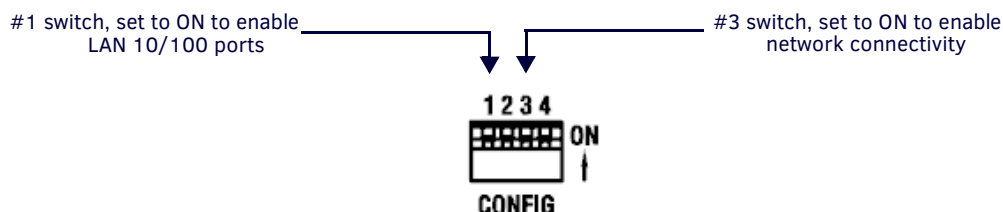

FIG. 37 Config DIP Switch

Connecting the Switcher to a Video Output

The switchers can transmit a signal simultaneously to both DXLink and HDMI outputs.

- The switcher uses standard HDMI cabling to connect to the HDMI output. Use an HDMI cable to connect the HDMI OUT port on the rear panel of the device to the display device. (On the SDX-51xM-DX, the HDMI OUT port is located on the front panel.)
- The switcher uses category cabling to connect to the DXLink output. See the *Important Twisted Pair Cabling Requirements and Recommendations* section on page 27 for information about cable requirements for the DXLink port. Use category cabling to connect the DXLINK port on the rear panel of the device to the DXLink input port on a DXLink receiver, Enova DVX switcher, or Enova DGX switcher. (On the SDX-51xM-DX, the DXLINK POWERED port is located on the front panel.)

Applying Power

Once you have mounted the switcher, set the DIP switches, and connected the appropriate input and output devices to the ports on the switcher, apply power by connecting the recommended power supply for your switcher. SDX-51xM-DX switchers include a universal power cord, so no external power supply is needed for that model of switcher.

The SDX-41x-DX and SDX-810-DX switchers require use of one of the following AMX power supplies (not included):

- PSR4.4, 13.5 VDC, 4.4 A Power Supply with 3.5mm Phoenix Connector with Retention Screws (**FG423-46**)
- PSN6.5, 13.5 VDC, 6.5 A Power Supply with (3) 3.5mm Phoenix Connectors (**FG423-41**)

Toggleing Between IP Addressing Modes: DHCP and Static IP

Solecis Digital Switchers support both DHCP and static IP addresses. When the #3 DIP switch is set to ON (see the *CONFIG DIP Switch* section on page 19), the switchers automatically use DHCP with link-local fallback. However, you can use a static IP address which you can set via a Telnet command (SET IP), or you can use the factory default static IP address. The default static IP address can be recalled at any time by resetting the unit to its factory default configuration. The default static IP address is 192.168.1.2. The default link-local address is 169.254.2.2. The switcher defaults to the link-local address if no IP address is obtained from a DHCP server.

The ID Pushbutton can be used to toggle between the DHCP and Static IP Modes.

Perform these steps to toggle between IP addressing modes:

1. After the switcher boots, press and hold the ID Pushbutton until the STATUS and LINK/ACT LEDs toggle back and forth in unison approximately 10 times.
2. Release the pushbutton when the LEDs start to blink faster.
 - When you release the Pushbutton, the switcher toggles either from static to dynamic (DHCP) IP addressing or vice versa and remains in that mode until you use the ID Pushbutton to toggle the IP mode again or you perform a factory reset.
 - The switcher automatically reboots to complete the process.

Assigning a Device Address (ID Mode)

You can use the ID Pushbutton in conjunction with the ID (Identify) Mode feature in NetLinx Studio. A momentary press of the ID Pushbutton assigns a device address to the switcher (which must be bound to the Master). You must first place the device in ID Mode in NetLinx Studio or the momentary press will be ignored.

NOTE: *The latest version of NetLinx Studio is available to download and install from www.amx.com. Refer to the NetLinx Studio online help for instructions on using the application.*

Perform these steps to assign a device address:

1. Check to be sure DIP switch #3 on the switcher is set to ON.
2. In NetLinx Studio's OnLine Tree, select the Master to which the switcher is bound.
3. From the Diagnostic menu, select Device Addressing. The Device Addressing dialog box opens.
4. In the ID Mode section, enter the Device and System numbers that you want assigned to the device in the appropriate text boxes.
5. Click Start Identify Mode to place the named system in ID Mode. The button changes to "Cancel Identify Mode" (click to cancel ID Mode). The text box below the button displays a "Waiting...Press Cancel to Quit" message.

NOTE: *When in ID Mode, the entire system is put on hold while it waits for an event from any NetLinx device in the named system (e.g., pressing the ID Pushbutton on the Receiver). The device that generates the first event is the device that will be "identified."*

6. Briefly press and release the ID Pushbutton on the switcher. The switcher will exhibit the following behavior:
 - Respond with an ID Mode address response.
 - Report its old address offline.
 - Report its new address online.

The Online Tree will refresh to display the new device address for the switcher.

NOTE: *NetLinx Studio (v3.3 or later) provides the ability to auto-increment IP Addresses and Hostnames as well as Device and System Numbers. Refer to the NetLinx Studio online help for details.*

Resetting the Factory Default Settings

During power up – if you hold the ID Pushbutton until the STATUS and LINK/ACT LEDs toggle back and forth in unison approximately 10 times, then release the pushbutton when the LEDs begin to blink faster, the switcher will reset to its factory default settings, which affect the parameters of the device, but not the firmware version.

Perform these steps to reset the factory default settings:

1. Press and hold the ID Pushbutton while plugging in the power connector. Start counting when the STATUS and LINK/ACT LEDs begin to flash in unison, not when the power connector is inserted.
 - Once the switcher has started booting, both STATUS and LINK/ACT LEDs flash in unison at the rate of once per second.
 - After 10 flashes at that rate, the LEDs will blink in unison at a faster rate.

NOTE: *A press-and-hold of the ID Pushbutton at power up will prevent the switcher from attempting to come online until the ID Pushbutton is released. The switcher will only attempt to come online if you release the Pushbutton prior to the faster blink rate.*

2. At the point that the blink rate increases, release the ID Pushbutton.
3. The switcher will automatically reboot to complete the process.

NOTE: *Typically, after a switcher boots, the last active input prior to the reboot becomes the active input when Auto Select is ENABLED. However, after a factory reset, the first input port will become active. If another signal is detected while Auto Select is enabled, the switcher will switch to that signal.*

Restore the Factory Firmware Image and Factory Default Parameters

During power up – if the ID Pushbutton is held until the STATUS and LINK/ACT LEDs toggle back and forth in unison approximately 30 times (10 slow, 20 fast) and then released when they go solid, the module's factory firmware image will be restored. This procedure affects both the firmware version and the parameters.

Perform these steps to restore the factory firmware image and factory default parameters:

1. Press and hold the ID Pushbutton while plugging in the power connector. Start counting when the STATUS and LINK/ACT LEDs begin to flash in unison, not when the power connector is inserted.
2. After the LEDs complete the following sequence, release the ID Pushbutton:
 - Once the switcher has started booting up, all LEDs flash in unison at the rate of once per second.
 - After 10 flashes at that rate, the LEDs will blink in unison at a faster rate.
 - After 10 seconds of flashing at the increased rate, all LEDs go to solid on.
3. Upon release of the ID Pushbutton, the switcher executes the following actions:
 - Restores itself to its factory firmware image.
 - Resets to factory default parameters
4. Once all actions in Step 3 are completed, the LEDs all turn off, indicating the switcher is ready to reboot.

The switcher automatically reboots to complete the process.

Factory Default Parameters

Factory Default Parameters	
Parameter	Value
MAC Address	As set in factory
Serial Number	As set in factory
Ethernet Mode	Auto (i.e. speed, duplex, both, auto)
IP Addressing Mode	DHCP
IP Address (for static mode)	192.168.1.2
Netmask (for static mode)	255.255.255.0
Gateway (for static mode)	192.168.1.1
DNS1 (for static mode)	192.168.1.1
DNS2 (for static mode)	192.168.1.1
DNS3 (for static mode)	192.168.1.1
DNS Domain	amx.com
Hostname	Last 7 digits of the serial number
Master Connection Mode	NDP - see the <i>Master Connection Modes</i> section on page 55
Master URL (for TCP and UDP URL modes)	"" (blank)
Master Connection Port Number (for TCP and UDP URL modes)	1319
Friendly-Name	"" (blank) NOTE: <i>If the Friendly Name is non-blank, both Friendly Name and Location are concatenated to make NDPSTRING2, otherwise NDPSTRING2 is generated from the unit's serial number.</i>
Location	"" (blank)
Stored MAC Address of Master (for NDP binding)	00:00:00:00:00:00
ICSP Device Number	0 (0 = receive dynamic device number from Master)
System Number	0
Telnet Port	23 A value of 0 disables the Telnet server. Telnet is enabled by default.

Video Switching

Overview

This chapter discusses the various methods you can use to change between video inputs on your switcher. You can use the following methods:

- Auto Switching Mode
- Manual Mode (Input selection via a physical button press or ICSP command)

Auto Switching Mode

Auto Switching mode is the default switching mode. With Auto Switching mode, the switcher responds to the most recently added video input by switching the new input to display on the HDMI and DXLink output.

- On the SDX-41x-DX and SDX-810-DX, if the selected input is removed, the switcher remains on that input.
- On the SDX-51xM-DX, if the selected input is removed, the switcher switches to the PC-IN input. If the PC-IN input is removed, the switcher remains on the PC-IN input.

NOTE: *If you reboot the switcher when Auto Switching is enabled, the switcher displays the last input selected before the reboot. If you manually select an input with an invalid signal before rebooting, the same input with the invalid signal will be displayed after the reboot.*

Auto Switching mode is enabled by default. You can disable Auto Switching mode by using the VIDIN_AUTO_SELECT command. See page 43 for more information on this command.

Manual Switching Mode

Manual Switching mode involves making a video input selection by a physical button press. The Select button on the front of the panel enables you to quickly cycle through all available inputs on the switcher. Each button press progresses the input selection to the next numbered input. Once you reach the end of the available inputs, the next button press returns the selection to video input position 1.

You can use the following NetLinx commands to select a video or audio input.

- See the *VI<input>O<output>* command on page 43 for information on the NetLinx command you can use to select the video input you want to use.
- See the *AI<input>O<output>* command on page 41 for information on the NetLinx command you can use to select an audio input.

NOTE: *The above commands are only available for use with the SDX-51xM-DX switcher.*

- See the *CI<input>O<output>* command on page 42 for information on the NetLinx command you can use to select both an audio and video input to send to the output.

All Cycle Contact Closure (SDX-51xM-DX only)

Each switcher features one or more External Button/LED Control connectors which match the functionality of the Select button when using a remote push button. The connectors enable you to cycle through all of the inputs in which each press results in a move to the next video input. See the *Dual External Button/LED Control Connectors* section on page 20 for more information.

Group Switching (SDX-51xM-DX only)

The SDX-51xM-DX has two sets of groups in which the first external button LED control connector is used to cycle through the inputs within a particular group. HDMI INPUT 1 is always the first input on both groups. Group 1 contains inputs 1, 2, and 3. Group 2 contains inputs 1, 4, and 5. You can route the audio/video from one input within a group at a time. You can cycle through the inputs in each group by clicking a single button module connected to the External button connector located next to HDMI INPUT 1 on the rear panel of the device. See the *GROUP INPUTS (SDX-51xM-DX only)* section on page 21 for more information.

NOTE: *Contact closures 3 and 5 are not tied to specific inputs, and are provided for an auxiliary button press trigger event notification which can be recognized by a NetLinx Master for programming purposes.*

Upgrading Firmware

Overview

The basic process of upgrading firmware on Solecis Digital Switchers involves downloading the latest firmware files from www.amx.com and using NetLinx Studio to transfer the files to a target switcher.

Use the OnLine Device tree in NetLinx Studio to view the firmware files currently loaded on the switcher. FIG. 38 shows an example OnLine Tree:

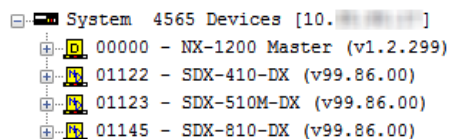

FIG. 38 NetLinx Studio - Sample Online Tree

Solecis Digital Switchers - Firmware Files

While the method of upgrading firmware files is the same for all Central switchers, there are some specific points relative to the specific model and type of switcher that must be noted:

- Upgrading the firmware on a Solecis Digital Switcher requires a firmware (*.kit) file.
- The number in parenthesis is the current switcher firmware version.

Before You Start

Verify you have the latest version of the NetLinx Studio application installed on your PC. NetLinx Studio is available to download from www.amx.com. Login to download the latest version. Alternatively, if it is already installed, use the Web Update option in NetLinx Studio's Help menu to obtain the latest version. The default location for the NetLinx Studio application is **Start > Programs > AMX Control Disc > NetLinx Studio > NetLinx Studio**.

- Verify that a LAN cable is connected from the switcher to the LAN Hub.
- Verify that the switcher is powered on.
- Connect to the switcher via IP address.
- Establish which version of firmware is currently loaded on the switcher (see *Verifying the Current Firmware Version* below).

Verifying the Current Firmware Version

Use the OnLine Tree in NetLinx Studio to verify which version of each firmware file is currently installed.

NOTE: *These steps assume that you have already established a connection with the target switcher.*

1. In NetLinx Studio, click on the OnLine Tree tab (in the Workspace Bar) to view the devices on the System.
2. Click Display and select Refresh System from the context menu. This establishes a new connection to the System and populates the device tree with devices on that system.
3. After the Communication Verification dialog indicates active communication between the PC and the Central switcher, verify the Central switcher and associated devices are listed in the OnLine Tree.
4. Check the appropriate product page on www.amx.com for the latest firmware files for your device.

If necessary, follow the procedures outlined in the following sections to obtain these firmware (*.kit) files from www.amx.com and then transfer the new firmware files to the device.

Downloading the Latest Firmware Files from www.amx.com

Visit the appropriate product page at www.amx.com for the latest Solecis Digital Switcher firmware (*.kit) file for your switcher. Firmware file links are available along the right-side of the catalog page (FIG. 39):

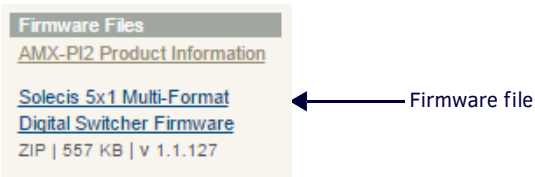

FIG. 39 Sample Switcher Firmware File Link from www.amx.com

Firmware files are bundled in a ZIP file, along with a Readme.TXT file that provides details on this firmware release.

NOTE: *Always read the Readme.TXT file included with the firmware file for any special instructions that may be required for an individual release.*

1. Accept the *AMX Licensing Agreement*.
2. Download the ZIP file and unzip the contents to a known location.

Upgrading Firmware via NetLinx Studio

NOTE: These steps assume that you have already established a connection with the target switcher (IP connection is preferred.)

1. In NetLinx Studio, click on the OnLine Tree tab (in the Workspace Bar) to view the devices on the System.
2. In the OnLine Tree tab, click **Display** and select **Refresh System** from the context menu. Selecting these options establishes a new connection to the System and populates the device tree with devices on that system.
3. After the Communication Verification dialog indicates active communication between the PC and the switcher, verify the switcher is listed in the OnLine Tree.
4. In NetLinx Studio, select **Tools > Firmware Transfers > Send to NetLinx Device** (FIG. 40).

The Send to NetLinx Device dialog opens.

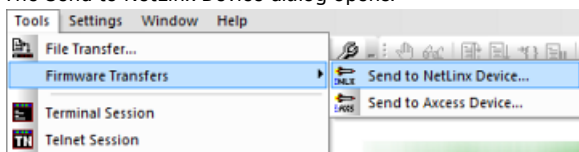

FIG. 40 NetLinx Studio - Tools > Firmware Transfers > Send to NetLinx Device

5. Click the **Browse** button (...) to locate and select the firmware (*.kit) file you want to transfer, in the Browse for Folders dialog. The selected file is indicated in the Files area.

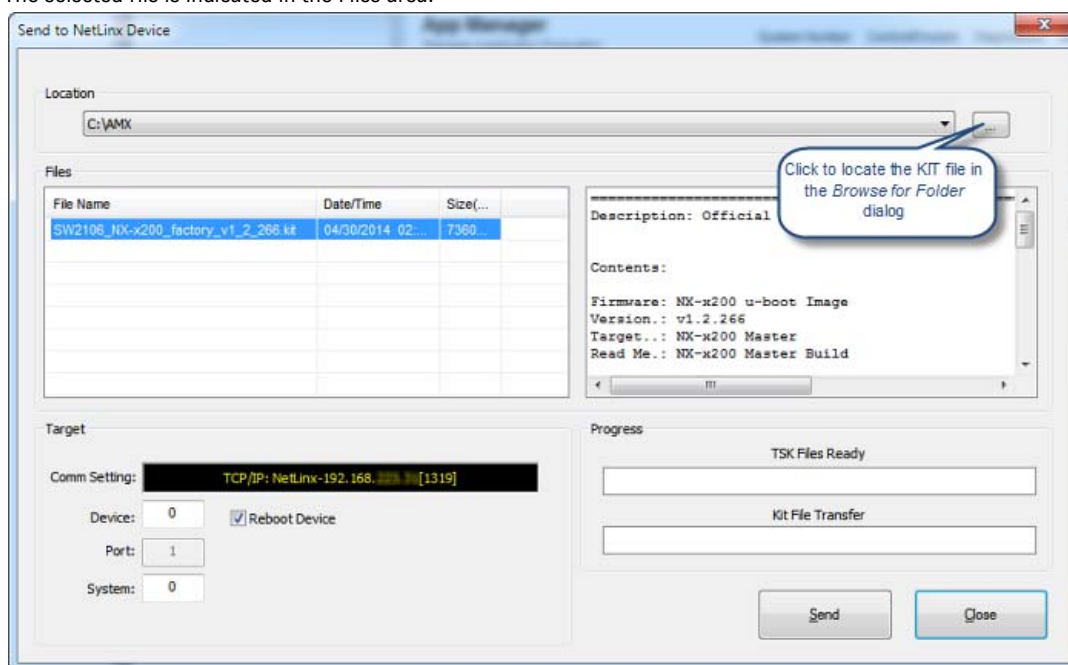

FIG. 41 NetLinx Studio - Send to NetLinx Device Dialog

6. Verify the target's System number matches the value listed within the active System folder in the OnLine Tree.
 - The *Device* number is always 0 for the switcher.
 - Note that the *Port* field is disabled (FIG. 42).

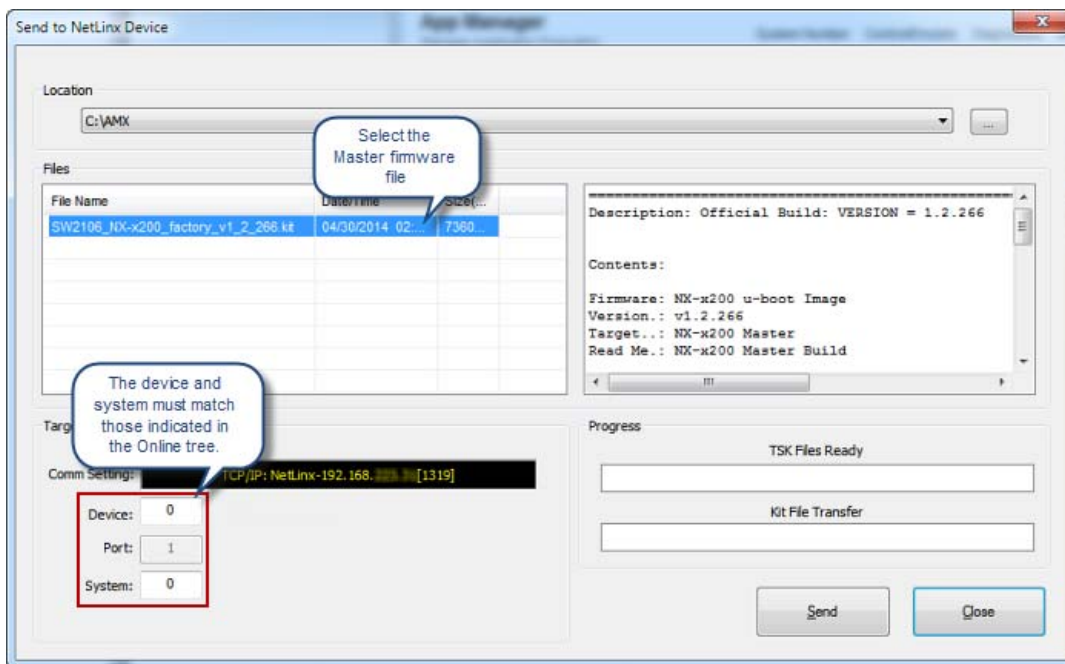

FIG. 42 Send to NetLinX Device dialog (showing on-board switcher firmware upgrade

7. Verify that the **Reboot Device** checkbox is selected to reboot the switcher after the firmware update process is complete (selected by default).
8. Click **Send** to begin the transfer. The file transfer progress is indicated in the Progress section of the dialog.
9. Click **Close** once the download process is complete.
10. In the OnLine Tree, right-click on the switcher and select **Refresh System**. This establishes a new connection and refreshes the device list and their firmware versions in your system.

Once the process is complete, you can upgrade the remaining firmware files. All device files must be kept at compatible firmware versions for proper operation. Therefore, all files should be used when upgrading any firmware associated with the Integrated switchers.

Programming

Overview

The chapter defines all programming commands available for the SDX Digital Switchers.

SEND_COMMANDS

The commands listed in the following sections are for the switcher only. For generic NetLinx commands, see the *NetLinx Integrated Switchers WebConsole and Programming Guide*.

- The commands derive their input/output port addressing from the target D:P:S.
- INPUT ports range from 1-8 for Audio/Video. HDMI inputs are capable of carrying both digital audio and video signals.
- Input and Output functional distinctions are disambiguated from the overlapped port numbers by combining them with the command name.

Port Functionality Mapping

The following table lists the port functionality mapping for the audio/video ports on the Solecis Digital Switchers:

Port Functionality Mapping				
Port	SDX-41x-DX	SDX-51xM-DX	SDX-810-DX	Address
HDMI IN 1	1	1	1	<DevID>:1:0
HDMI IN 2	2	2	2	<DevID>:2:0
HDMI IN 3	3	n/a	3	<DevID>:3:0
HDMI IN 4	4	4	4	<DevID>:4:0
HDMI IN 5	n/a	n/a	5	<DevID>:5:0
HDMI IN 6	n/a	n/a	6	<DevID>:6:0
HDMI IN 7	n/a	n/a	7	<DevID>:7:0
HDMI IN 8	n/a	n/a	8	<DevID>:8:0
HDMI OUT	1	1	1	<DevID>:1:0
DXLINK OUT	1	1	1	<DevID>:1:0
VGA IN 3	n/a	3	n/a	<DevID>:3:0
VGA IN 5	n/a	5	n/a	<DevID>:5:0
USB Device	n/a	12	n/a	<DevID>:12:0
USB Host	n/a	13	n/a	<DevID>:13:0
External Buttons	14	14	14	<DevID>:14:0
AxLink Keypad 1	15	15	15	<DevID>:15:0
AxLink Keypad 2	17	17	17	<DevID>:17:0

NOTE: The AxLink Device Address DIP Switch on supported AxLink keypads determines the port number used by the keypads. The ports are assigned from the lowest DIP switch device setting to the highest, where the lowest DIP switch address gets the lower port number (15) and the higher DIP switch address gets the higher port number (17).

AUDIO SEND_COMMANDS

The following table lists the audio SEND_COMMANDS available for the Solecis Digital Switchers:

Audio SEND_COMMANDS	
AI<input>O<output>	<p>Switches audio input port <input> to output port <output>.</p> <p>NOTE: This command is only compatible with the SDX-51xM-DX. Use the CI<input>O<output> command to switch audio on the SDX-41x-DX and SDX-810-DX.</p> <p>CAUTION: Do not route input 0 to the output to mute the audio. Doing so can cause a loss of audio after a system shut down. To mute the audio, use the AUDOUT_MUTE command.</p> <p>Syntax: SEND_COMMAND "AI<input>O<output>"</p> <p>Variables: input = The source audio input number. output = The output port number to use.</p> <p>Example: SEND_COMMAND SWITCHER, "AI2O1" Switch audio input port #2 to output #1.</p>
?AUDIN_FORMAT	<p>Requests the input format of the audio port addressed by the D:P:S.</p> <p>Syntax: SEND_COMMAND <DEV>, "?AUDIN_FORMAT"</p> <p>Example: SEND_COMMAND AUDIO_INPUT_1, "?AUDIN_FORMAT" Returns a COMMAND string of the form: AUDIN_FORMAT-<HDMI SPDIF ANALOG></p>
AUDIN_FORMAT	<p>Sets the input format of the audio port addressed by the D:P:S to HDMI, SPDIF, or ANALOG.</p> <p>Syntax: SEND_COMMAND <DEV>, "AUDIN_FORMAT-<format>"</p> <p>Variables: format = HDMI, SPDIF, ANALOG</p> <p>Example: SEND_COMMAND VIDEO_INPUT_1, "AUDIN_FORMAT-<HDMI>" Sets the format of audio input port (#1 based on D:P:S) to HDMI.</p>
?AUDIN_FORMAT_AUTO	<p>Requests the setting (Enabled or Disabled) for automatically detecting the audio source format through the switcher.</p> <p>Syntax: SEND_COMMAND <DEV>, "?AUDIN_FORMAT_AUTO"</p> <p>Example: SEND_COMMAND AUDIO_INPUT_1, "?AUDIN_FORMAT_AUTO" Returns a COMMAND string of the form: AUDIN_FORMAT_AUTO-<setting>.</p>
AUDIN_FORMAT_AUTO	<p>Sets the audio source format to automatically detect the audio through the switcher. This feature is enabled by default.</p> <p>Syntax: SEND_COMMAND <DEV>, "AUDIN_FORMAT_AUTO-<ENABLE DISABLE>"</p> <p>Example: SEND_COMMAND AUDIO_INPUT_1, "AUDIN_FORMAT_AUTO-ENABLE"</p>
?AUDOUT_ASSIGN	<p>Requests the audio input that is selected to go to the output.</p> <p>Syntax: SEND_COMMAND <DEV>, "?AUDOUT_ASSIGN"</p> <p>Example: SEND_COMMAND AUDIO_1, "?AUDOUT_ASSIGN" Returns a COMMAND string of the form: AUDOUT_ASSIGN-<setting>.</p>
?AUDOUT_FORMAT	<p>Requests the audio output format for the switcher.</p> <p>Syntax: SEND_COMMAND <DEV>, "?AUDOUT_FORMAT"</p> <p>Example: SEND_COMMAND AUDIO_OUTPUT_1, "?AUDOUT_FORMAT" Returns a COMMAND string of the form: AUDOUT_FORMAT-<format>.</p>
AUDOUT_FORMAT	<p>Sets the audio output source format for the switcher.</p> <p>Syntax: SEND_COMMAND <DEV>, "AUDOUT_FORMAT-<format>"</p> <p>Variable: format = HDMI, DXLINK, or ALL</p> <p>Example: SEND_COMMAND AUDIO_OUTPUT_1, "AUDOUT_FORMAT-HDMI"</p>

Audio SEND_COMMANDS (Cont.)	
?AUDOUT_MUTE	<p>Requests the setting for the Mute preference of the audio output. The audio output is set by AUDOUT_FORMAT.</p> <p>Syntax: SEND_COMMAND <DEV>, "'?AUDOUT_MUTE'"</p> <p>Example: SEND_COMMAND dxDev, "'?AUDOUT_MUTE'"</p> <p>Returns a COMMAND string of the form: AUDOUT_MUTE-<ENABLE DISABLE>.</p>
AUDOUT_MUTE	<p>Enable or disable audio muting on the ports specified by AUDOUT_FORMAT. The mute state works as follows:</p> <p>Setting: AUDOUT_MUTE = ENABLE AUDOUT_FORMAT - HDMI (HDMI audio muted, DXLINK audio off) AUDOUT_FORMAT - DXLINK (HDMI audio off, DXLINK audio muted) AUDOUT_FORMAT - ALL (HDMI audio muted, DXLINK audio muted)</p> <p>Setting: AUDOUT_MUTE = DISABLE AUDOUT_FORMAT - HDMI (HDMI audio plays, DXLINK audio off) AUDOUT_FORMAT - DXLINK (HDMI audio off, DXLINK audio plays) AUDOUT_FORMAT - ALL (HDMI audio plays, DXLINK audio plays)</p> <p>Syntax: SEND_COMMAND <DEV>, "'AUDOUT_MUTE-<ENABLE DISABLE>'"</p> <p>Example: SEND_COMMAND dxDev, "'AUDOUT_MUTE-DISABLE'"</p>
CI<input>O<output>	<p>Switches both the audio and video input to the output port.</p> <p>CAUTION: Do not route input 0 to the output to mute the audio. Doing so can cause a loss of audio after a system shut down. To mute the audio, use the AUDOUT_MUTE command.</p> <p>Syntax: SEND_COMMAND <DEV>, "'CI<input>O<output>'"</p> <p>Variables: input = The source input port number. output = The output port number to use.</p> <p>Examples: SEND_COMMAND SWITCHER, "'CI2O1'"</p> <p>Switches (audio/video) input port #2 to output #1.</p>

Video SEND_COMMANDS

The following table lists the video SEND_COMMANDS available for the SDX Digital Media Switchers:

Video SEND_COMMANDS	
?EXTERNAL_BUTTON_ACTION	<p>Requests the external button action option setting on the switcher.</p> <p>Syntax: SEND_COMMAND <DEV>, "'?EXTERNAL_BUTTON_ACTION'"</p> <p>Example: SEND_COMMAND SWITCHER, "'?EXTERNAL_BUTTON_ACTION'"</p> <p>Returns a COMMAND string of the form: EXTERNAL_BUTTON_ACTION<CYCLE DIRECT>.</p>
EXTERNAL_BUTTON_ACTION	<p>Sets the external button behavior to Cycle or Direct. On the SDX-51xM-DX, setting DIP switch 4 to ON sets the external button behavior to Direct mode. See the <i>CONFIG DIP Switch</i> section on page 19 for more information.</p> <p>NOTE: <i>The Cycle and Direct options are only applicable with the SDX-51xM-DX. You can only set the SDX-41x-DX and SDX-810-DX to Direct.</i></p> <p>In Cycle mode, an external button press results in a move to the next video input (see the <i>All Cycle Contact Closure (SDX-51xM-DX only)</i> section on page 36 for more information.) In Direct mode, the external buttons directly relate to the input (external button 1 selects input 1, external button 2 selects button 2, etc.)</p> <p>NOTE: <i>The only valid port that can receive this command is port 1.</i></p> <p>Syntax: SEND_COMMAND <DEV>, "'EXTERNAL_BUTTON_ACTION-<CYCLE DIRECT>'"</p> <p>Example: SEND_COMMAND SWITCHER, "'EXTERNAL_BUTTON_ACTION-CYCLE'"</p>
VI<input>O<output>	<p>Switches the video input to the output port. Set <input> to 0 to send audio with no video.</p> <p>NOTE: <i>This command is only compatible with the SDX-51xM-DX. Use the CI<input>O<output> command to switch video on the SDX-41x-DX and SDX-810-DX.</i></p> <p>Syntax: SEND_COMMAND <DEV>, "'VI<input>O<output>'"</p> <p>Variables: input = The source video input port number. output = The video output port number to use.</p> <p>Example: SEND_COMMAND SWITCHER, "'VI201'"</p> <p>Switch video input port #2 to video output #1.</p>
?VIDIN_AUTO_SELECT	<p>Requests setting for the Auto Select mode for the video input signal on the switcher.</p> <p>Syntax: SEND_COMMAND <DEV>, "'?VIDIN_AUTO_SELECT'"</p> <p>Example: SEND_COMMAND VIDEO_INPUT_1, "'?VIDIN_AUTO_SELECT'"</p> <p>Returns a COMMAND string of the form: VIDIN_AUTO_SELECT-<status>.</p>
VIDIN_AUTO_SELECT	<p>Enables or disables the Auto Select mode for the video input signal on the switcher. When AUTO_SELECT is enabled, the TX will automatically switch to a newly detected video input. This feature is enabled by default.</p> <p>Syntax: SEND_COMMAND <DEV>, "'VIDIN_AUTO_SELECT-<ENABLE DISABLE>'"</p> <p>Example: SEND_COMMAND VIDEO_INPUT_1, "'VIDIN_AUTO_SELECT-ENABLE'"</p>
?VIDIN_EDID	<p>Requests the EDID mode for the specified video input port.</p> <p>Syntax: SEND_COMMAND <DEV>, "'?VIDIN_EDID'"</p> <p>Example: SEND_COMMAND VIDEO_INPUT_1, "'?VIDIN_EDID'"</p> <p>Returns a COMMAND string of the form: VIDIN_EDID-<source>. See the <i>VIDIN_EDID</i> command for the list of potential sources.</p>

Video SEND_COMMANDs (Cont.)	
VIDIN_EDID	<p>Sets the EDID Mode for the specified video input port addressed by D:P:S. The EDID mode is the desired EDID information to be sent to the selected video source.</p> <p>Syntax: SEND_COMMAND <DEV>, "'VIDIN_EDID-<source>'"</p> <p>Variables: The source variable includes the following options: All Resolutions - uses the pre-loaded EDID for the switcher Mirror Out 1 - uses the EDID from DXLink (display on DX-RX, DVX input, or DGX input) Mirror Out Local - uses the EDID of the local display Mirror Out 1 HDMI - uses the EDID of the local display Mirror Out 1 DXLINK - uses the EDID from DXLink (display on DX-RX, DVX input, or DGX input) User EDID 1 - uses a custom VGA-only EDID, loaded onto the switcher from an outside source (see Appendix C for more information.)</p> <p>NOTE: User EDID 1 is only available for VGA. Mirror is only applicable to HDMI.</p> <p>NOTE: Mirror Out 1 is interchangeable with Mirror Out 1 DXLINK, and Mirror Out Local is interchangeable with Mirror Out 1 HDMI. Use the argument which is compatible with your video input device.</p> <p>CAUTION: If you are using the VIDIN_EDID command to mirror the DXLink or HDMI port and the sink (TV) is not plugged into the output port, the switcher may receive an invalid EDID. Be sure to issue the command when the sink is plugged into the output port.</p> <p>Example: SEND_COMMAND VIDEO_INPUT_1, "'VIDIN_EDID-MIRROR OUT 1'"</p>
?VIDIN_EDID_AUTO	<p>Requests the status of the EDID update setting for the video port addressed by the D:P:S.</p> <p>Syntax: SEND_COMMAND <DEV>, "'?VIDIN_EDID_AUTO'"</p> <p>Example: SEND_COMMAND VIDEO_INPUT_1, "'?VIDIN_EDID_AUTO'"</p> <p>Returns a COMMAND string of the form: VIDIN_EDID-<ENABLE DISABLE>.</p>
VIDIN_EDID_AUTO	<p>Enables or disables whether the video input port addressed by D:P:S is supposed to have its list of available resolutions for the EDID source auto detected.</p> <p>Syntax: SEND_COMMAND <DEV>, "'VIDIN_EDID_AUTO-<ENABLE DISABLE>'"</p> <p>Example: SEND_COMMAND VIDEO_INPUT_1, "'VIDIN_EDID_AUTO-ENABLE'"</p>
?VIDIN_FORMAT	<p>Requests the input format of the video port addressed by the D:P:S.</p> <p>Syntax: SEND_COMMAND <DEV>, "'?VIDIN_FORMAT'"</p> <p>Example: SEND_COMMAND VIDEO_INPUT_1, "'?VIDIN_FORMAT'"</p> <p>Returns a COMMAND string of the form: VIDIN_FORMAT-<HDMI DVI VGA>.</p>
?VIDIN_HDCP	<p>Queries the video input HDCP compliance setting of the video input port addressed by the D:P:S.</p> <p>NOTE: This command is only available on HDMI inputs ports on Solecis devices.</p> <p>Syntax: SEND_COMMAND <DEV>, "'?VIDIN_HDCP'"</p> <p>Example: SEND_COMMAND VIDEO_INPUT_1, "'?VIDIN_HDCP'"</p> <p>Returns a string of the form: VIDIN_STATUS-<ENABLE DISABLE>.</p>

Video SEND_COMMANDs (Cont.)	
VIDIN_HDCP	<p>Sets the video input HDCP compliance setting of the video input port addressed by the D:P:S. Always select the input prior to enabling/disabling HDCP on it. When VIDIN_HDCP is disabled, the addressed video input will appear to any source as not being HDCP compliant. For computer sources that encrypt all video when connected to an HDCP compliant display, disabling HDCP compliance on the input will cause the computer to send non-encrypted video which can then be routed to non-compliant displays and video conferencing systems.</p> <p>NOTE: <i>It may be necessary to disconnect and reconnect PC sources after changing this setting.</i></p> <p>CAUTION: <i>Disabling HDCP compliance for sources that do not support non-compliant displays (such as DVD and Blu-Ray players) is not recommended and may affect Solecis performance.</i></p> <p>Syntax: SEND_COMMAND <DEV>, "'VIDIN_HDCP-<option>'"</p> <p>Variables: option = ENABLE, DISABLE (default = ENABLE)</p> <p>Example: SEND_COMMAND VIDEO_INPUT_1, "'VIDIN_HDCP-ENABLE'"</p> <p>Enables the HDCP compliance of video input port (#1 based on D:P:S).</p> <p>NOTE: <i>Only applicable on HDMI ports of Solecis switchers (not VGA inputs).</i></p>
?VIDIN_HSHIFT	<p>Requests the input Horizontal shift of the VGA video port addressed by the D:P:S.</p> <p>Syntax: SEND_COMMAND <DEV>, "'?VIDIN_HSHIFT'"</p> <p>Example: SEND_COMMAND VIDEO_INPUT_1, "'?VIDIN_HSHIFT'"</p> <p>Returns a COMMAND string of the form: VIDIN_HSHIFT-<value>.</p>
VIDIN_HSHIFT	<p>Sets the horizontal shift of the video port addressed by the D:P:S to <value>.</p> <p>NOTE: <i>This command is only valid for VGA inputs.</i></p> <p>Syntax: SEND_COMMAND <DEV>, "'VIDIN_HSHIFT-<value>'"</p> <p>Variables: value = -50..50</p> <p>Example: SEND_COMMAND "'VIDIN_HSHIFT-2'"</p> <p>Sets the Horizontal shifting of the video input port (#1 based on D:P:S) to 2 (shift to right).</p> <p>SEND_COMMAND "'VIDIN_HSHIFT--3'"</p> <p>Sets the horizontal shifting of the video input port (#1 based on D:P:S) to -3 (shift to left).</p>
?VIDIN_PHASE	<p>Requests the input phase of the video port addressed by the D:P:S. This command is valid only for inputs whose format is set to VGA.</p> <p>Syntax: SEND_COMMAND <DEV>, "'?VIDIN_PHASE'"</p> <p>Example: SEND_COMMAND VIDEO_INPUT_1, "'?VIDIN_PHASE'"</p> <p>Returns a COMMAND string of the form: VIDIN_PHASE-<value>.</p>
VIDIN_PHASE	<p>Sets the input phase of the video port addressed by the D:P:S to <value>. This command is valid only for inputs whose format is set to VGA.</p> <p>Syntax: SEND_COMMAND <DEV>, "'VIDIN_PHASE-<value>'"</p> <p>Variables: value = 0..31</p> <p>Example: SEND_COMMAND VIDEO_INPUT_1, "'VIDIN_PHASE-23'"</p> <p>Sets the phase of video input port to 23.</p>
?VIDIN_PREF_EDID	<p>Requests the preferred resolution of the EDID source for the selected video input. This command only applies if you select All Resolutions with the VIDIN_EDID command.</p> <p>Syntax: SEND_COMMAND <DEV>, "'?VIDIN_PREF_EDID'"</p> <p>Example: SEND_COMMAND VIDEO_INPUT_1, "'?VIDIN_PREF_EDID'"</p> <p>Returns a COMMAND string of the form: VIDIN_PREF_EDID-<resolution, refresh>.</p>

Video SEND_COMMANDS (Cont.)	
VIDIN_PREF_EDID	<p>Sets the preferred resolution of the EDID source for the specified video input.</p> <p>NOTE: <i>This command only applies if you select All Resolutions with the VIDIN_EDID command.</i></p> <p>Syntax: SEND_COMMAND <DEV>, "'VIDIN_PREF_EDID-<resolution, refresh>'"</p> <p>Variables: resolution, refresh = The resolution and refresh rate for the EDID source.</p> <p>NOTE: <i>For a list of supported input resolutions and refresh rates, see the Appendix B - Supported Resolutions section on page 57.</i></p> <p>Example: SEND_COMMAND VIDEO_INPUT_1, "'VIDIN_PREF_EDID-1920x1080p,60'"</p>
?VIDIN_RES_REF	<p>Requests the resolution of the video input port addressed by the D:P:S.</p> <p>Syntax: SEND_COMMAND <DEV>, "'?VIDIN_RES_REF'"</p> <p>Example: SEND_COMMAND VIDEO_INPUT_1, "'?VIDIN_RES_REF'"</p> <p>Returns a COMMAND string of the form: VIDIN_RES_REF-<h>x<v>,<rate>.</p>
VIDIN_RES_REF	<p>Sets the resolution and refresh rate of the video input port addressed by D:P:S. Invalid combinations are ignored by the SWITCHER.</p> <p>NOTE: <i>This command is only valid for the analog ports on the SDX-51xM-DX.</i></p> <p>Syntax: SEND_COMMAND <DEV>, "'VIDIN_RES_REF-<horizontal>x<vertical>,<refresh-rate>'"</p> <p>Variables: horizontal = An integer value representing the horizontal. vertical = An integer value representing the vertical. May have an additional qualifier such as 'i' or 'p'. refresh-rate = An integer value representing the refresh rate.</p> <p>Example: SEND_COMMAND VIDEO_INPUT_1, "'VIDIN_RES_REF-1920x1080,60'"</p> <p>For a list of supported resolutions, see the <i>Appendix B - Supported Resolutions</i> on page 57.</p>
?VIDIN_STATUS	<p>Requests the video input status of the video input port addressed by the D:P:S</p> <p>Syntax: SEND_COMMAND <DEV>, "'?VIDIN_STATUS'"</p> <p>Example: SEND_COMMAND VIDEO_INPUT_1, "'?VIDIN_STATUS'"</p> <p>Returns a COMMAND string of the form: VIDIN_STATUS-<status string> status string = NO SIGNAL, UNKNOWN SIGNAL, or VALID SIGNAL.</p>
?VIDIN_VSHIFT	<p>Requests the input Vertical shifting of the RGB video port addressed by the D:P:S. This command is only available on VGA inputs.</p> <p>Syntax: SEND_COMMAND <DEV>, "'?VIDIN_VSHIFT'"</p> <p>Example: SEND_COMMAND VIDEO_INPUT_1, "'?VIDIN_VSHIFT'"</p> <p>Returns a COMMAND string of the form: VIDIN_VSHIFT-<value>.</p>
VIDIN_VSHIFT	<p>Sets the vertical shift of the video port addressed by the D:P:S to <value>. This command is only available on VGA inputs.</p> <p>Syntax: SEND_COMMAND <DEV>, "'VIDIN_VSHIFT-<value>'"</p> <p>Variables: value = -10..10</p> <p>Example: SEND_COMMAND "'VIDIN_VSHIFT-2'" Sets the vertical shifting of the video input port to 2 (shift upward). SEND_COMMAND "'VIDIN_VSHIFT--3'" Sets the vertical shifting of the video input port to -3 (shift downward).</p>
?VIDOUT_ASSIGN	<p>Requests the video input that is selected to go to the output.</p> <p>Syntax: SEND_COMMAND <DEV>, "'?VIDOUT_ASSIGN'"</p> <p>Example: SEND_COMMAND SWITCHER, "'?VIDOUT_ASSIGN'"</p> <p>Returns a COMMAND string of the form: VIDOUT_ASSIGN-<setting>.</p>

Video SEND_COMMANDs (Cont.)	
?VIDOUT_MUTE	<p>Requests to see if VIDEO mute is enabled or disabled.</p> <p>Syntax: SEND_COMMAND <DEV>, "'?VIDOUT_MUTE'"</p> <p>Example: SEND_COMMAND SWITCHER, "'?VIDOUT_MUTE'"</p> <p>Returns a COMMAND string of the form: VIDOUT_MUTE<ENABLE DISABLE>.</p>
VIDOUT_MUTE	<p>Enables or disables VIDEO mute. The output ports (HDMI, DXLINK) can enable/disable video mute individually or simultaneously.</p> <p>Syntax: SEND_COMMAND <DEV>, "'VIDOUT_MUTE-<setting>'"</p> <p>Variable: setting = desired mute state (ENABLE, DISABLE, ENABLE-HDMI, DISABLE-HDMI, ENABLE-DXLINK, DISABLE-DXLINK)</p> <p>Example: SEND_COMMAND SWITCHER, "'VIDOUT_MUTE-ENABLE'"</p>
?VIDOUT_SLEEP	<p>Requests to see if the video sleep option is enabled or disabled.</p> <p>Syntax: SEND_COMMAND <DEV>, "'?VIDOUT_SLEEP'"</p> <p>Example: SEND_COMMAND SWITCHER, "'?VIDOUT_SLEEP'"</p> <p>Returns a COMMAND string of the form: VIDOUT_SLEEP<ENABLE DISABLE>.</p>
VIDOUT_SLEEP	<p>When enabled, if there is no active video input selected, the selected HDMI output turns off transition-minimized differential signaling (TMDS) after a period of time.</p> <p>NOTE: <i>The only valid port that can receive this command is port 1.</i></p> <p>Syntax: SEND_COMMAND <DEV>, "'VIDOUT_SLEEP-<ENABLE DISABLE>'"</p> <p>Example: SEND_COMMAND SWITCHER, "'VIDOUT_SLEEP-ENABLE'"</p>

USB SEND_COMMANDS

The following table lists the USB SEND_COMMANDS available for the Solecis Digital Switchers:

USB SEND_COMMANDS	
?USB_HID_CONFIG	<p>Requests the current state of USB_HID pass through on the system.</p> <p>Syntax: <code>SEND_COMMAND <DEV>, "'?USB_HID_CONFIG'"</code></p> <p>Example: <code>SEND_COMMAND SWITCHER, "'?USB_HID_CONFIG'"</code></p> <p>Returns a COMMAND string of the form: USB_HID_CONFIG-<DEVICE NONE>.</p>
USB_HID_CONFIG	<p>Enables or disables the USB_HID pass through.</p> <p>Syntax: <code>SEND_COMMAND <DEV>, "'USB_HID_CONFIG-<DEVICE or NONE>'"</code> 'DEVICE' enables pass through.'NONE' disables it.</p> <p>Example: <code>SEND_COMMAND SWITCHER, "'USB_HID_CONFIG-DEVICE'"</code></p> <p>NOTE: You must reboot the transmitter for the transmitter to recognize the USB device.</p>

System SEND_COMMANDS

The following table lists the System SEND_COMMANDS available for the Solecis Digital Switchers:

System SEND_COMMANDS	
?FWVERSION	<p>Requests the firmware version of the switcher.</p> <p>Syntax: <code>SEND_COMMAND <DEV>, "'?FWVERSION'"</code></p> <p>Example: <code>SEND_COMMAND SWITCHER, "'?FWVERSION'"</code></p> <p>Returns a COMMAND string of the form: FWVERSION-<version>.</p>
REBOOT	<p>Reboots the device.</p> <p>Syntax: <code>SEND_COMMAND DEVICE_1, "'REBOOT'"</code></p>

Appendix A - Telnet (Terminal) Commands

Establishing a Terminal Connection via Telnet

Telnet terminal communication is accessed remotely via TCP/IP. The Transmitter must have its own IP address for a Telnet connection. The connection can be started from the Windows taskbar or in NetLinx Studio.

By default, a User Name and Password are not applied to the Telnet port (Port 23). Therefore, the port does not require login credentials.

Establishing a terminal connection via Telnet at the CMD prompt

Perform these steps to establish a terminal connection via Telnet at the CMD prompt:

1. From your Windows Taskbar (at the far left), select **Start > Run** to open the Run dialog box.
2. Type cmd in the Open field.
3. Click **OK** to open an instance of the Windows command interpreter (cmd.exe).
4. At the prompt (>), type telnet followed by a space and the switcher's IP address.

Example:

```
>telnet XXX.XXX.XXX.XXX
```

A Telnet session opens for the Transmitter and the welcome banner appears.*

5. At the prompt, type the Telnet command (see the table starting on page 50) and press Enter.

* If you are using Windows 7 and receive an error message, you may need to enable Telnet by completing the following: (1) go to **Start > Control Panel > Programs and Features**, (2) on the left, select **Turn Windows features on or off**, (3) select the **Telnet Client** and **Telnet Server check-boxes**, and (4) click **OK**.

Establishing a terminal connection via NetLinx Studio

Perform these steps to establish a terminal connection via NetLinx Studio:

1. In the Online Tree, select the switcher and right-click to access the short-cut menu.
2. Select **Launch Telnet Window via NetLinx Studio**. The Telnet window opens and the welcome banner appears.
3. At the prompt (>), type the Telnet command and press Enter.

Telnet Username and Password

The following commands are used to set the Telnet username and password for a Telnet connection:

- Set Telnet Username
- Set Telnet Password

By default, both the username and password are blank (empty strings). Performing a factory reset on the device with the Pushbutton will return these values to that default.

- Username – Setting the Username will have no effect if the password remains blank (empty string). That is, defining the username alone will not result in Telnet prompting for a user login.
- Password – Setting the Password will cause Telnet to prompt for a user login, whether the username has been defined or not. If the username has been defined, this value must be entered. However, since the password can be set independently of the username, it's possible to have a password defined, but the username still at its default (blank, empty string). In this case do not enter anything for the username when prompted. Simply press Enter, which will then present the password prompt. Here, the defined password must be entered in order to successfully open the Telnet session.

Additional Notes

- Both the Telnet username and password are case-sensitive.
- Three consecutive, unsuccessful attempts to log in to Telnet will cause the Telnet window to close. Relaunching Telnet will again present the login prompt, with a fresh "batch" of login attempts.
- If a Telnet login fails because of an incorrect username, an "Invalid Password" message will appear (as opposed to an "Invalid Username" message).
- The username and password are saved after reboot or power cycle.
- The username and password are deleted/removed after a factory reset.

Setting a Telnet Username and Password

Perform these steps to set a Telnet username and password:

1. Establish a terminal connection via Telnet.
2. Type Set Telnet Username, and press Enter.
 - The program will prompt you to enter a new Telnet username; enter a username and press Enter.
 - The program will indicate that the username is being stored.
3. Type Set Telnet Password, and press Enter.
 - The program will prompt you to enter a password; press Enter twice to clear both the Telnet username and password.
 - Enter a password and press Enter.
 - The program will prompt you to re-enter the password; re-enter the password and press Enter.
 - The program will indicate that the password is being stored.

Telnet Commands

The Telnet commands listed in the table below can be sent directly to the switcher via a Telnet terminal session.

- The default Telnet port is 23. A value of 0 (zero) disables the Telnet server.
- Telnet is enabled by default.

In the terminal program, type Help or a question mark (?) and press Enter to access the Help Menu and display the terminal commands described in the table below.

Telnet Commands	
Command	Description
? or Help	Display the commands listed in this table.
DEVICE STATUS	<p>Displays device status of a specified device, port, system (<D:P:S>).</p> <p>NOTE: <i>Devices other than the switcher itself will be ignored.</i></p> <p>Example:</p> <pre>>device status 32002:1:0 Device Status ----- Device 1123 AMX LLC, SDX-510M-DX, v99.86.00 contains 17 Ports Port 1 - Channels:255 Levels:0 MaxStringLen=64 Types=8 bit MaxCommandLen=64 Types=8 bit The following output channels are on:None ></pre>
DIPSWITCH	<p>Displays the current value for each of the DIP switch's four toggles.</p> <p>Example:</p> <pre>>dipswitch Dipswitch - ON OFF OFF OFF ></pre>
EXIT	Exit the Telnet session.
FACTORYFWIMAGE	Resets unit to factory firmware image and reboots the switcher.

Telnet Commands (Cont.)	
Command	Description
GET CONFIG	<p>Displays the current connection settings.</p> <p>Example:</p> <pre>>get config Device number: 7010 Connection Settings ----- Mode: NDP System Number: 2155 Master IP/URL: 192.168.43.83 Master Port: 1319 Username: Password: IP Settings ----- HostName: SDX-510-000-EXB Type: DHCP IP Address: 192.168.43.63 Subnet Mask: 255.255.255.0 Gateway IP: 192.168.43.2 MAC Address: 00:60:9f:99:26:f1 DHCP Server : 192.168.43.2 Lease Origin : THU 01/09/2031 12:59:02 Lease Duration : SUN 01/12/2031 12:59:02 (259200 sec) Lease Renew (T1) : SAT 01/11/2031 00:59:02 (129600 sec) Lease Rebind (T2) : SUN 01/12/2031 03:59:02 (226800 sec) DNS Servers ----- Domain suffix: amx.internal Entry 1: 192.168.40.7 Entry 2: 192.168.40.8</pre> <p>NOTE: The system number and IP addressing information displayed is reflective of actual operating values, not stored parameters.</p>
GET CONNECTION	<p>Shows the Master connection information.</p> <p>Example:</p> <pre>>get connection Connection Settings ----- Mode: UDP URL System Number: 1 Master IP/URL: 192.168.44.53 Master Port: 1319 Username: Password:</pre>
GET DEVICE	Displays the device number.
GET DNS	<p>Gets the list of DNS entries.</p> <p>Example:</p> <pre>>get dns DNS Servers ----- Domain suffix: amx.internal Entry 1: 192.168.40.7 Entry 2: 192.168.40.8</pre> <p>NOTE: When the switcher is in DHCP Mode, these are active values, NOT the stored values that only apply to Static IP Mode.</p>

Telnet Commands (Cont.)	
Command	Description
GET FRIENDLY	Displays the device's friendly name (for NDP).
GET IP	Displays the IP configuration of a device. The device displays its D:P:S, Host Name, Type (DHCP or Static), IP Address, Subnet Mask, Gateway IP, and MAC Address. Example: <pre>>GET IP HostName SDX-510-000-EXB Type DHCP IP Address 192.168.43.63 Subnet Mask 255.255.255.0 Gateway IP 192.168.43.2 MAC Address 00:60:9f:99:26:f1 [[also displays "Lease" details; see example for GET CONFIG command]]</pre>
GET LOCATION	Displays the location parameter for NDP, which is set by using the SET LOCATION command (see page 54).
GET SN	Returns the device's serial number.
MSG [ON OFF]	Enables/Disables extended diagnostic messages. <ul style="list-style-type: none"> MSG ON [error warning info debug] sets the terminal program to display log messages generated by the Master. The level of log printed to the terminal window depends both on the level used when sending the message and the output level selected with "msg on." For example if log output is enabled via "msg on warning" then logs produced at levels AMX_ERROR and AMX_WARNING will be displayed, but not logs produced at levels AMX_INFO or AMX_DEBUG. The order of severity from highest to lowest is ERROR, WARNING, INFO, DEBUG. If no severity is supplied with "msg on," the default setting is WARNING. <ul style="list-style-type: none"> MSG OFF disables the display. Example: <pre>> MSG ON Extended diagnostic information messages turned on. > MSG OFF Extended diagnostic information messages turned off.</pre>
NDP UNBIND	Clears the NDP binding to a Master (takes effect after next boot).
PING [ADDRESS]	Pings an address (IP or URL), to test network connectivity to and confirms the presence of another networked device. The syntax matches the PING application in Windows or Linux. Example: <pre>>ping 192.168.29.209 192.168.29.209 is alive.</pre>
REBOOT	Reboots the switcher. Example: <pre>>REBOOT Rebooting...</pre>
RENEW DHCP	Renews/releases the current DHCP lease for the switcher. NOTE: Because sending this command can result in the unit acquiring a new DHCP address and the USB functionality of the endpoints is dependent on the mated IP addresses of the TX (host) and RX (device), the USB connection may need to be re-established. Example: <pre>>RENEW DHCP</pre>
RESET FACTORY	Resets the device's stored parameters to factory default state including removal of all security settings, resetting to DHCP. This command will cause an automatic reboot. NOTE: This command does not reset the device to the factory software image.
SEND_COMMAND [D:P:S,"command"]	Sends the specified SEND_COMMAND (does not work with queries) to the current switcher. NOTE: Commands cannot be forwarded to other D:P:S. Asynchronous notifications are available for the switchers via Telnet (and NetLinx Studio). Example: <pre>send_command 6501:1:0,"VIDIN_AUTO_SELECT-ENABLE"</pre>

Telnet Commands (Cont.)	
Command	Description
SEND_STRING [D:P:S,"string"]	Sends the specified SEND_STRING to the current switcher or connected Master. NOTE: <i>Commands cannot be forwarded to other D:P:S. Asynchronous notifications are available for the switchers via Telnet (and NetLinX Studio).</i> Example: send_string 32001:1:1,"27,18,0"
SET CONNECTION	Sets the Master connection settings interactively, allowing the user to specify the mode (for descriptions of various connection modes, see page 55). <ul style="list-style-type: none"> • If the mode is TCP or UDP, the Master URL and port number can be specified as well. • If Auto is selected, the System number can be specified. • After all data is entered, if the parameters have changed, the switcher will disconnect from the Master, and begin trying to connect with the new settings. NOTE: <i>These changes do not require a reboot to take effect.</i>
SET DEVICE	Sets the device number, and stores it in non-volatile memory. Syntax: SET DEVICE <num> The valid range of device numbers is 0 to 31999. <ul style="list-style-type: none"> • If the user enters a number outside that range, then no change will be made and the switcher will issue an error message. • A Device Number of '0' means that the switcher will accept the auto-assigned device number from the Master. • If the new device number is different from the old device number, the switcher will disconnect from the Master, and begin trying to connect with the new settings. NOTE: <i>These changes do not require a reboot to take effect.</i>
SET DNS	Sets the DNS configuration of the switcher, only as applied to Static IP Mode (DNS settings in DHCP Mode are received from the DHCP server). Syntax: SET DNS This command prompts you to enter a Domain Name, DNS IP #1, DNS IP #2, and DNS IP #3. <ul style="list-style-type: none"> • Enter Y (yes) to approve/store the information in the Master. • Enter N (no) cancels the operation. NOTE: <i>The device must be rebooted to enable new settings.</i> Example: >SET DNS -- Enter New Values or just hit Enter to keep current settings -- Enter Domain Suffix: amx.com Enter DNS Entry 1 : 192.168.20.5 Enter DNS Entry 2 : 12.18.110.8 Enter DNS Entry 3 : 12.18.110.7 You have entered: Domain Name: amx.com DNS Entry 1: 192.168.20.5 DNS Entry 2: 12.18.110.8 DNS Entry 3: 12.18.110.7 Is this correct? Type Y or N and Enter -> Y Settings written. Device must be rebooted to enable new settings
SET ETHERNET MODE	This command sets the current LAN configuration settings per new mode. Syntax: SET ETHERNET MODE <newmode> Values for <i>newmode</i> are: auto Or 10 full, 100 full, 10 half, or 100 half NOTE: <i>This command requires a reboot to enable new settings.</i> Examples: set ethernet mode auto set ethernet mode 100 full

Telnet Commands (Cont.)	
Command	Description
SET FRIENDLY	<p>Set the device's friendly name for NDP to <name>.</p> <p>Syntax:</p> <pre>SET FRIENDLY <name></pre> <ul style="list-style-type: none"> Maximum length = 25 characters. If the name entered exceeds 25 characters, it will be truncated. The value is stored in non-volatile memory. If no value specified, an automatic name consisting of AMX, the product name, and serial number will be used. <p>NOTE: <i>This command requires a reboot to enable new settings.</i></p>
SET IP	<p>Sets the IP configuration of a specified device.</p> <p>Enter a Host Name, Type (DHCP or Fixed), IP Address, Subnet Mask, and Gateway IP Address.</p> <p>IMPORTANT: <i>Host Names may only contain ASCII letters "a" through "z" (not case-sensitive), digits "0" through "9", and the hyphen ("-").</i></p> <p>NOTE: <i>Note: DHCP implies "DHCP with link-local fallback".</i></p> <p>NOTE: <i>Note: For NetLinx Masters, the Host Name can only consist of alphanumeric characters.</i></p> <ul style="list-style-type: none"> Enter Y (yes) to approve/store the information on the Master. Enter N (no) to cancel the operation. <p>NOTE: <i>This command requires a reboot to enable new settings.</i></p> <p>Example:</p> <pre>>SET IP --- Enter New Values or just hit Enter to keep current settings --- Enter Host Name: DXL-RX-36d0110 Enter IP type. Type D for DHCP or S for Static IP and then Enter: DHCP You have entered: Host Name DXL-RX-36d0110 Type DHCP Is this correct? Type Y or N and Enter -> y Settings written. Device must be rebooted to enable new settings.</pre> <p>NOTE: <i>The switcher can also be set to Static IP or DHCP Mode via the front panel ID Pushbutton.</i></p>
SET LOCATION	<p>Sets the location parameter for NDP.</p> <p>Syntax:</p> <pre>SET LOCATION <location></pre> <p>Maximum length = 25 characters. If the name entered exceeds 25 characters, it will be truncated.</p> <p>NOTE: <i>This command requires a reboot to enable new settings.</i></p>
SET TELNET PORT	<p>Sets the device's IP port listened to for Telnet connections.</p> <p>Example:</p> <pre>>SET TELNET PORT Current telnet port number = 23 Enter new telnet port number (Usually 23)(0 = disable Telnet): Once you enter a value and press the Enter key, you get the following message: Setting telnet port number to 23 New telnet port number set, reboot the device for the change to take effect.</pre> <p>NOTE: <i>This command requires a reboot to enable new settings.</i></p>
SET TELNET USERNAME	<p>NOTE: <i>This command is supported but is not presently in the Help file list of commands.</i></p> <p>Sets the Username for a secure Telnet session.</p> <ul style="list-style-type: none"> Default = blank (no username required) For details, see the <i>Telnet Username and Password</i> section on page 49.
SHOW CONNECTION LOG	Shows the Master connection log for the device.

Telnet Commands (Cont.)	
Command	Description
SHOW CONNECTION STATS	Shows the connection statistics for the device. Output similar to the following example: <pre>>show connection stats Connection Statistics Total Last 15 Minutes ===== ICSP Messages: 10039 received 333 received 10038 transmitted 333 transmitted Blink Messages: 5014 received 166 received IP Statistics: RX packets:29298 errors:0 discarded:0 TX packets:15286 errors:0 discarded:0</pre>
SHOW LOG	Displays the message log. Syntax: <pre>SHOW LOG <start></pre> <ul style="list-style-type: none"> • Use <start> to specify the message number to start displaying. • Use <all> to display all messages.
SHOW VS100 STATS	When sent to the Solecis switcher, this command retrieves the DXLink quality information from the receiver (or switcher input) to which it is connected.

Master Connection Modes

The mode of communication used for connection to the Master is specified via the SET CONNECTION Telnet command (see page 53).

Connection mode setting options are AUTO, TCP URL, UDP URL, or NDP (default) as described:

- **AUTO** – This mode utilizes TCP communication. It looks for a matching System Number and attempts to come online with the first Master it sees with that System Number.
- **TCP URL** – TCP; the Master is specified via URL.
- **UDP URL** – UDP; the Master is specified via URL.
- **NDP** – UDP; this mode utilizes the NDP binding process to assign the switcher (the physical device) to a Master (or Virtual Master) via NetLinx Studio. Once bound, communications are conducted via UDP.

NOTE: *In URL modes, the Master can use either an IP address or a DNS name.*

Guidelines

UDP mode is recommended for the following types of installations:

- Small-to-medium residential and corporate installations on a single subnet
- Segmented control network installations (control network is a separate switching domain and subnet from other network equipment)
- Installations with the total number of NetLinx / ICSNET devices on a single Master exceeding 128

TCP mode is recommended for installations where (a) the switching domain of the network is subject to “bursty” traffic or heavy streaming activity (>20 Mbps consumption by streaming) and where (b) the total number of NetLinx / ICSNET devices on a single Master is less than 128.

TCP vs. UDP

- **TCP** – Protocol has a built-in retry mechanism.
- **UDP** – Protocol does not have a built-in retry mechanism, but consumes fewer resources on the Master. AMX’s UDP implementation of NetLinx employs a retry mechanism to provide the reliability of TCP with the resource efficiency of UDP.

URL vs. NDP vs. Auto

Determining which connection method to use for Master Connection Mode is essentially a matter of deciding what information the device should use to identify the correct Master to which you want to connect.

The default mode is NDP; the mode can be changed via the SET CONNECTION Telnet command (see page 53).

- **URL** – The device connects to the Master with the specified URL. The device must be configured with the URL of a specific Master via the SET CONNECTION Telnet command (see page 53).
- **NDP** – The device connects to the Master it's been bound to, which is based on the Master's MAC address. The binding is configured via NetLinx Studio. Once bound, the device must be unbound using either NetLinx Studio or the Telnet NDP UNBIND command before being re-bound to a different Master. Alternatively, NDP devices can be bound/unbound via options on the Master's Web Configuration pages (System > Manage NetLinx). For details, refer to the WebConsole & Programming Guide – NX-Series Controllers (System - Manage NetLinx section).
- **Auto** – The device connects to the first Master it finds with the specified System Number. The device must be configured with the desired system number via the SET CONNECTION Telnet command (see page 53). Use of this method requires that only one Master has any particular system number and is visible to the subnet. If this is the case, then Auto is the simplest choice. However, with Auto, you are not hard-bound to a particular Master. Therefore, if at some point in the future, another Master is configured with the same system number, the result is that the switcher could show up on that other Master.

Notes on Specific Telnet Clients

Telnet and terminal clients exhibit different behaviors in some situations. This section states some of the known anomalies.

Windows Client Programs

Anomalies occur when using a Windows® client if you are not typing standard ASCII characters (i.e., using the keypad and the Alt key to enter decimal codes). Most programs will allow you to enter specific decimal codes by holding Alt and using keypad numbers. For example, hold Alt, hit the keypad 1, then hit keypad 0, then release Alt. The standard line feed code is entered (decimal 10). Windows will perform an ANSI to OEM conversion on some codes entered this way because of the way Windows handles languages and code pages.

The following codes are known to be altered, but others may be affected depending on the computer's setup.

- Characters **15**, **21**, **22**, and **any characters above 127**.

This affects both Windows Telnet and Terminal programs.

Linux Telnet Client

The Linux Telnet client has three anomalies that are known at this time:

- A null (\00) character is sent after a carriage return.
- If an "Alt 255" is entered, two of the "255" characters are sent (per the Telnet RAFT).
- If the code to return to Command mode is entered (Alt 29 which is ^]), the character is not sent, but the Telnet Command Mode is entered.

Appendix B - Supported Resolutions

Available Pixel Display and Refresh Rates

The available pixel display and refresh rates for the input devices connected to the switcher are listed in this appendix.

DVI, HDMI, and VGA Supported Input Resolutions

DVI, HDMI, and VGA Supported Input Resolutions							
Resolution	Horizontal Active Pixels	Vertical Active Lines	Refresh (Hz)	HDMI & DVI Support	VGA Support	Comments	Video Standard
640x400@85	640	400	85	✓	✓		VESA DMT
640x480@60	640	480	60	✓	✓		VESA DMT
640x480@72	640	480	72	✓	✓		VESA DMT
640x480@75	640	480	75	✓	✓		VESA DMT
640x480@85	640	480	85	✓	✓		VESA DMT
720x400@85	720	400	85	✓	✓		VESA DMT
720x480p@60	720	480	60	✓	✓	480p	CEA 861
720x480p@120	720	480	120	✓	✓	480p	CEA 861
720x480p@240	720	480	240	✓	✓	480p	CEA 861
720x576p@50	720	576	50	✓	✓	576p	CEA 861
720x576p@100	720	576	100	✓	✓	576p	CEA 861
720x576p@200	720	576	200	✓	✓	576p	CEA 861
800x600@56	800	600	56	✓	✓		VESA DMT
800x600@60	800	600	60	✓	✓		VESA DMT
800x600@72	800	600	72	✓	✓		VESA DMT
800x600@75	800	600	75	✓	✓		VESA DMT
800x600@85	800	600	85	✓	✓		VESA DMT
848x480@60	848	480	60	✓	✓		VESA DMT
848x480@75	848	480	75	✓	✓		VESA CVT
848x480@85	848	480	85	✓	✓		VESA CVT
1024x640@60	1024	640	60	✓	✓		VESA CVT
1024x768@60	1024	768	60	✓	✓		VESA DMT
1024x768@70	1024	768	70	✓	✓		VESA DMT
1024x768@75	1024	768	75	✓	✓		VESA DMT
1024x768@85	1024	768	85	✓	✓		VESA DMT
1152x864@75	1152	864	75	✓	✓		VESA DMT
1280x720@60	1280	720	60	✓	✓		VESA CVT
1280x720p@60	1280	720	60	✓	✓	720p	CEA 861
1280x720p@100	1280	720	100	✓	✓	720p	CEA 861
1280x720p@120	1280	720	120	✓	✓	720p	CEA 861
1280x768@60	1280	768	60	✓	✓		VESA DMT
1280x768@75	1280	768	75	✓	✓		VESA DMT
1280x768@85	1280	768	85	✓	✓		VESA DMT
1280x800@60	1280	800	60	✓	✓		VESA CVT
1280x960@60	1280	960	60	✓	✓		VESA DMT
1280x960@85	1280	960	85	✓	✓		VESA DMT
1280x1024@60	1280	1024	60	✓	✓		VESA DMT
1280x1024@75	1280	1024	75	✓	✓		VESA DMT
1280x1024@85	1280	1024	85	✓	✓		VESA DMT

DVI, HDMI, and VGA Supported Input Resolutions (Cont.)							
Resolution	Horizontal Active Pixels	Vertical Active Lines	Refresh (Hz)	HDMI & DVI Support	VGA Support	Comments	Video Standard
1360x768@60	1360	768	60	✓	✓		VESA DMT
1400x1050@60	1400	1050	60	✓	✓		VESA DMT
1400x1050@75	1400	1050	75	✓	✓		VESA DMT
1440x900@60	1440	900	60	✓	✓		VESA DMT
1440x900@75	1440	900	75	✓	✓		VESA DMT
1440x900@85	1440	900	85	✓	✓		VESA DMT
1600x1200@60	1600	1200	60	✓	✓		VESA DMT
1680x1050@60	1680	1050	60	✓	✓		VESA CVT
1920x1080i@50	1920	540	50	✓		HDMI & DVI only - 1080i	CEA 861
1920x1080i@60	1920	540	60	✓		HDMI & DVI only - 1080i	CEA 861
1920x1080p@25	1920	1080	25	✓	✓	1080p	CEA 861
1920x1080p@30	1920	1080	30	✓	✓	1080p	CEA 861
1920x1080p@50	1920	1080	50	✓	✓	1080p	CEA 861
1920x1080@60	1920	1080	60		✓	VGA only	VESA CVT
1920x1080p@60	1920	1080	60	✓	✓	1080p	CEA 861
1920x1200@60	1920	1200	60	✓	✓	Reduced Blanking	VESA CVT
3840x2160p@24	3840	2160	24	✓			
3840x2160p@25	3840	2160	25	✓			
3840x2160p@30	3840	2160	30	✓			
4096x2160p@24	4096	2160	24	✓			
4096x2160p@25	4096	2160	25	✓			
4096x2160p@30	4096	2160	30	✓			

Appendix C - EDID Programming (SDX-51xM-DX only)

DGX Configuration Software Overview

IMPORTANT: Because signals routed through DXLink Transmitters normally produce a quality image, you will not need the information in this appendix unless the installation has special EDID requirements for VGA.

AMX's DGX Configuration Software has a tabbed view for EDID Programming. This view can be used to re-program the EDID EEPROM chips for the HD-15 connectors on the SDX-51xM-DX, allowing for custom configuration of the EDID data that is stored on them.

NOTE: The remaining tabbed views in the software do not apply to the DXLink units. Scaling and HDCP settings can be applied via SEND_COMMANDs (see the NetLinx Programming of DXLink Transmitters and Receivers chapter in the DXLink Twisted Pair Transmitters/Receivers Instruction Manual for more information). If a DXLink Receiver is connected to an Enova DGX Output Board, DGX Configuration Software can be used via the switcher for scaling (see the Enova DGX 8/16/32/64 Instruction Manual).

DGX Configuration Software is available at www.amx.com (on the Multi-Format Transmitter's product page) and includes a standard Help file with detailed information.

NOTE: To upload a custom VGA EDID using DGX Configuration Software, DIP switch 4 on the SDX-51xM-DX must be set to OFF. After setting the DIP switch, you must reboot the switcher before using the DGX Configuration Software.

PC System Requirements for DGX Configuration Software

- Windows 7 and Windows XP Professional
- Minimum Hardware: 166 MHz, 128 MB RAM, 36 MB of free disk space*, 800x600 display, serial port, video card with dual outputs (see Caution below)
- Recommended Hardware: 2.0 GHz, 512 MB RAM*

* Installing the DGX Configuration Software requires 36 MB of disk space for the software installer. Once installed, the software requires 10 MB of disk space.

CAUTION: AMX strongly urges you to not use video cards with DMS-59 connectors. Video cards with DMS-59 connectors have been shown to fail consistently and, in the worst case, can corrupt an EDID data file. A laptop PC with a VGA or DVI out is a good solution. Cards with 2 DVI connectors, 2 VGA connectors, or 1 DVI and 1 VGA connector are also acceptable.

Software Installation on PC

IMPORTANT: Administrator rights are required to install DGX Configuration Software.

Installing DGX Configuration Software

1. On the Tech Center page at www.amx.com, select **Application Files** in the left column, then click **Digital Media Switchers**. Click **DGX Configuration Software**.
2. Click **I Accept** for the AMX License Agreement, and then select **Open** to download the file.
3. Optional – Select *DGX_Config_SoftwareReadMe_vX_X* to read about the software before installation.
4. Click the application file (which is zipped).
5. In the Compressed (zipped) Folders dialog box, click **Extract All**.
6. Select a destination for the files.
7. When the download is complete, click the application file and follow the directions in the installation wizard.

DXLink Connection to PC

Using DGX Configuration Software with an SDX-51xM-DX

1. Attach one end of a USB mini-B cable to the Program port on the rear of the SDX-51xM-DX.
2. Attach the open end of the USB mini-B cable to the PC where the DGX Configuration Software was installed.
3. Apply power to the switcher.
4. On the PC, open the DGX Configuration Software.

NOTE: The PC will automatically establish a virtual COM port on the switcher.

5. If changing the communication settings is necessary*:
 - From the Communication menu (in the DGX Configuration Software), select **Serial Port**. Select **Change Settings** to change the serial port and/or the baud rate for the PC's serial port. The baud rate for the PC must match the baud rate for the switcher. The recommended (default) baud rate setting for USB serial communication with the switcher is 9600.
 - If you changed any of the settings, from the Communication menu select **Refresh Device Lists**.

6. Select the EDID Programmer tab in the interface (defaults to the Scaler Mode tab**).

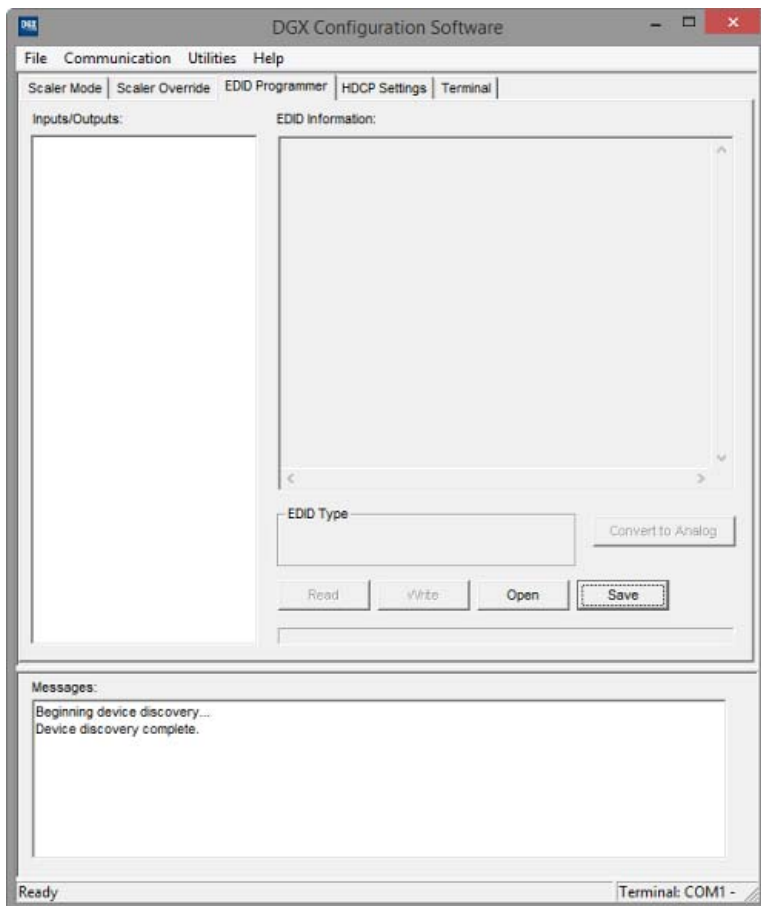

FIG. 43 DGX Configuration Software Tool

* If you are unsure of the USB Serial Port (COM <number>) being used, on the PC go to Start > Control Panel > Device Manager and expand the "Ports" to verify the COM number.

** The remaining tabs do not apply to the switcher. Scaling and HDCP settings can be applied via SEND_COMMANDS (see the *NetLink Programming of DXLink Transmitters and Receivers* chapter in the *DXLink Twisted Pair Transmitters/Receivers Instruction Manual* for more information).

General Notes for Working with DGX Configuration Software and the SDX-51xM-DX

When the SDX-51xM-DX is connected to a PC running DGX Configuration Software, the following applies:

- DGX Configuration Software displays the connected switcher only.
- File menu — Select Open File to load an .edid file to the program. Select Save to File to save an .edid file containing the currently displayed settings in the EDID Programmer view.
- Communication menu — Use to change the serial communication settings. This menu also includes the option to "Refresh Device Lists" which will refresh the device list in the EDID Programmer tab.
- Utilities menu — This menu does not apply to the DXLink Transmitters.
- Help menu — Access the Help file for the program, open a link for the Web Update option (to download updates for the program), and view current version information.
- Messages in the bottom pane of the DGX Configuration Software dialog box report status of operations. Messages can be copied* for technical support purposes.

* Right-click on a message to access a short-cut menu with options to Copy Selected, Copy All, or Clear. When copying multiple messages: either select consecutive items by holding down the Shift key and clicking the first and last item or select nonconsecutive items by holding down the Control key and clicking on each item.

EDID Programmer View

From the EDID Programmer view, EDID EEPROM chips for the HD-15 (VGA) connector on the switcher can be re-programmed if necessary.

NOTE: *The EDID Programmer will not work in conjunction with the HDMI connector on the TX.*

EDID Overview

EDID (Extended Display Identification Data) is a data structure established by the Video Electronics Standards Association (VESA) to enable plug-and-play support by enabling easy configuration of a computer's graphics subsystem based on the capabilities of the attached display device.

EDID information includes items such as the following:

- Manufacturer's name
- Product type
- Supported video resolutions and refresh rates
- Color space and filter chromaticity
- Detailed timings

When a computer is directly connected to a display device, it can use the display device's EDID information to determine an initial compatible video signal to send. With the computer's display controls, the user can modify this selection to another compatible signal based on the provided EDID information.

DXLink Equipment and EDID

In cases where the HD-15 (VGA) input on a switcher are used and a resolution incompatibility exists (or if the source device needs a specific resolution or a limited set of resolutions), the switchers have the ability to update the VGA EDID emulation file (by updating the EEPROM chip) which comes preloaded with an AMX VGA EDID set.

The AMX VGA EDID set consists of a number of common EDID settings. In most cases, the switcher can be used as is from the factory with no adjustments.

The DGX Configuration Software with EDID programming functionality has been provided for cases where a user defined VGA EDID set is desired.

The EDID Programmer view can be used for writing user defined VGA EDID data to the switcher's HD-15 input.

Reading and Saving EDID Data from a Switcher's HD-15 (VGA) Input Connector

The DGX Configuration Software reads the EDID data from the USER EDID 1 EEPROM location, regardless of the VIDIN_EDID setting.

IMPORTANT: *Unless a custom EDID has been previously written to the input, attempting to read the EDID will result in a Read Error message.*

The EDID data can be read to confirm the correct EDID has been programmed.

Reading and Saving EDID Data from a Switcher

1. On the PC, open the DGX Configuration Software and select the EDID Programmer tab.
2. Under Inputs/Outputs on the left, expand the device tree, and select the HD-15 input.
3. Click Read to read the VGA EDID information currently on the HD-15 input. The EDID data appears in the EDID read-only field on the right.

NOTE: *In the EDID Programmer view, the Save to File option under the File menu can be used to save the EDID information as an .edid file. The saved file can be opened as a text file (from the File menu, select **Open File**) and edited or opened and written to an input (click the **Write** button).*

Rear Error Message

A Read Error message will appear if the switcher has never been programmed with a valid/custom EDID or if the unit has been programmed with a corrupted EDID. A Read Error message will also appear when attempting to read the EDID after sending a FACTORYAV SEND_COMMAND, which re-initializes the VGA USER EDID 1 EEPROM and resets the VIDIN_EDID setting to ALL RESOLUTIONS (which is AMX_0500_003).

Writing EDID Data to a Switcher's HD-15 (VGA) Input Connector

The instructions that follow tell how to use the EDID Programmer view to write user defined VGA EDID information to the HD-15 input connector on a switcher. User-defined VGA EDIDs are currently available from technical support.

AMX EDID Library

A library of VGA EDID files are available at www.amx.com (search for EDID Library). This library provides EDID files that can be used with AMX products. A report is provided for each EDID file, which describes the EDID features in detail, in order to assist you in selecting the most appropriate EDID for your system needs.

- Check the Library to determine if one of the custom EDID files meets your needs. (The custom EDID files are variants of base/standard EDIDs.)
- DGX Configuration Software can be used to reprogram the EDID on the input port with one of the .edid files provided in the EDID Library.

Writing VGA EDID Data to a Switcher

1. Download the VGA EDID set provided by technical support.
2. On the PC, open the DGX Configuration Software and select the **EDID Programmer** tab.
3. Under Inputs/Outputs on the left, expand the device tree, and select the HD-15 input. From the File menu, select **Open File** to select the VGA .edid file that was downloaded in Step 1.
4. Click **Write** to write the VGA EDID information to the HD-15 input.

NOTE: You can confirm that the new VGA EDID data was written to the HD-15 input by selecting the HD-15 input and clicking on the Read button or by using the `SEND_COMMAND ?VIDIN_EDID`, which will return: `VIDIN_EDID-USER EDID 1`.

IMPORTANT: You can revert to the factory default EDID for the HD-15 input by using the `SEND_COMMAND VIDIN_EDID-ALL RESOLUTIONS` (i.e., `AMX_0500_003`).



© 2016 Harman. All rights reserved. Solecis, NetLinx, Enova, HydraPort, Metreau, AMX, AV FOR AN IT WORLD, and HARMAN, and their respective logos are registered trademarks of HARMAN. Oracle, Java and any other company or brand name referenced may be trademarks/registered trademarks of their respective companies.

AMX does not assume responsibility for errors or omissions. AMX also reserves the right to alter specifications without prior notice at any time.

The AMX Warranty and Return Policy and related documents can be viewed/downloaded at www.amx.com.

3000 RESEARCH DRIVE, RICHARDSON, TX 75082 AMX.com | 800.222.0193 | 469.624.8000 | +1.469.624.7400 | fax 469.624.7153

AMX (UK) LTD, AMX by HARMAN - Unit C, Auster Road, Clifton Moor, York, YO30 4GD United Kingdom • +44 1904-343-100 • www.amx.com/eu/



Last Revised:
12/16/2016